

QZA-IMPLANT
CATALOG

INDEX

- 4 QZA-Implant Overview
- 8 QZA-Implant Platform Definition

9 QZA-IMPLANTS & SURGICAL COMPONENTS

- 10 QZA-Implant Size Range
- 11 QZA-Implant Surgical Components
- 12 QZA-Implant Insertion Components
- 13 QZA-Implant Surgical Kit
- 15 Q-Implant System Drill Stop Kit

17 SURGICAL PROTOCOLS

- 19 QZA-Implant Surgical Protocols
- 20 QZA-Implant Surgical Steps
- 24 QZA-Implant Insertion
- 25 QZA-Implant Packaging Handling

27 PROSTHETIC COMPONENTS

- 28 QZA-Implant Prosthetic Components
- 33 QZA-Implant Healing Abutments
- 34 QZA-Implant Temporary Abutments
- 35 QZA-Implant UCLA Castable Abutments
- 37 QZA-Implant Titanium Base Abutments
- 38 QZA-Implant Q-Cone Abutments
- 40 QZA-Implant Straight Abutments
- 41 QZA-Implant Angled Abutments
- 44 QZA-Implant Preparable Abutment
- 45 QZA-Implant Q-Ball Abutments
- 49 QZA-Implant Q-Lock Abutments
- 52 QZA-Implant Multi-Unit Abutments
- 54 QZA-Implant Prosthetic Instruments

55 IMPLANTOLOGY PRODUCTS

- 56 Q-Bone Pin Kit
- 57 Q-Bone Pin System and Q-Mesh
- 58 Q-MultiTractor
- 60 Reverse Guide Implant Technique
- 61 Twisted Trocar Screw
- 62 Q-Bone Graft Kit
- 63 Q-Implant Family
- 65 Q-Implant Marathon Implantology Courses

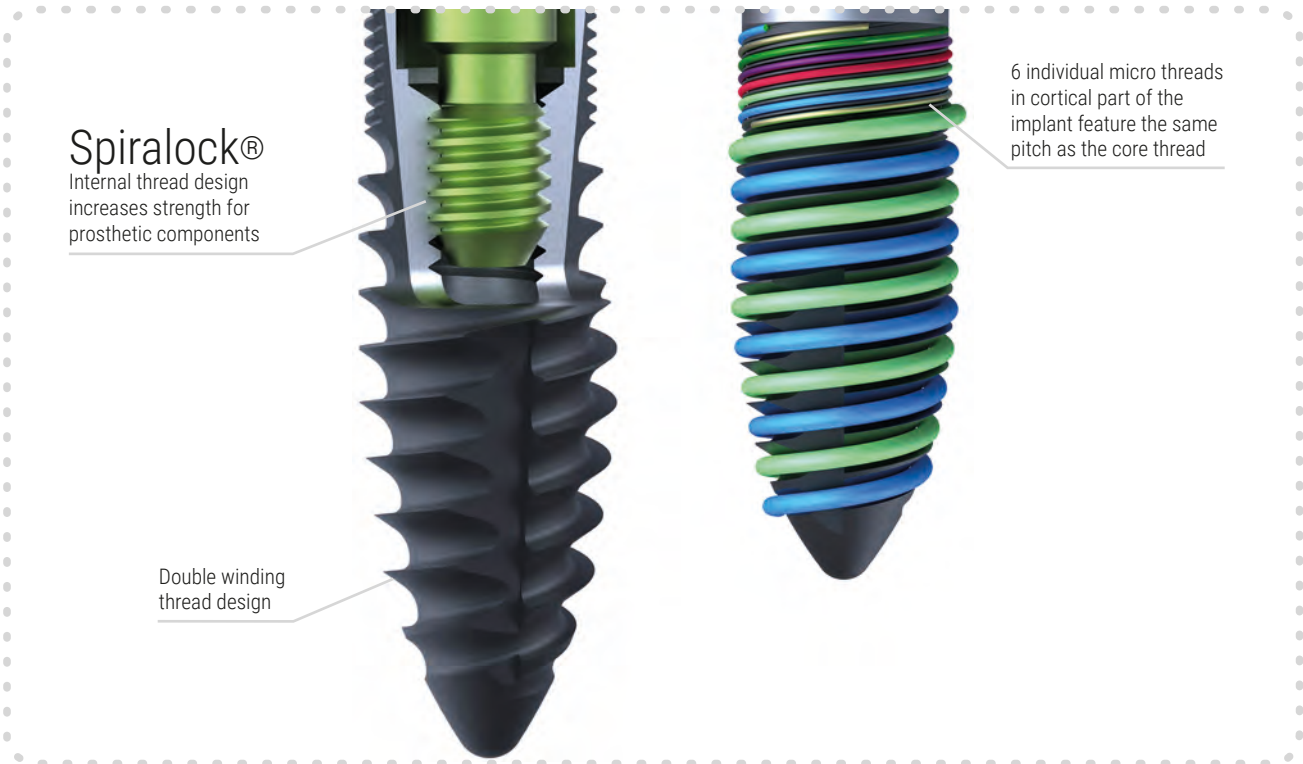

– "3 easily identifiable
platforms for efficient
prosthetic restoration"

– "Two-stage bone level
implant with internal
hexagonal connection"



NOTE: Please consult on contra-indications for respective diameters in the instructions of use

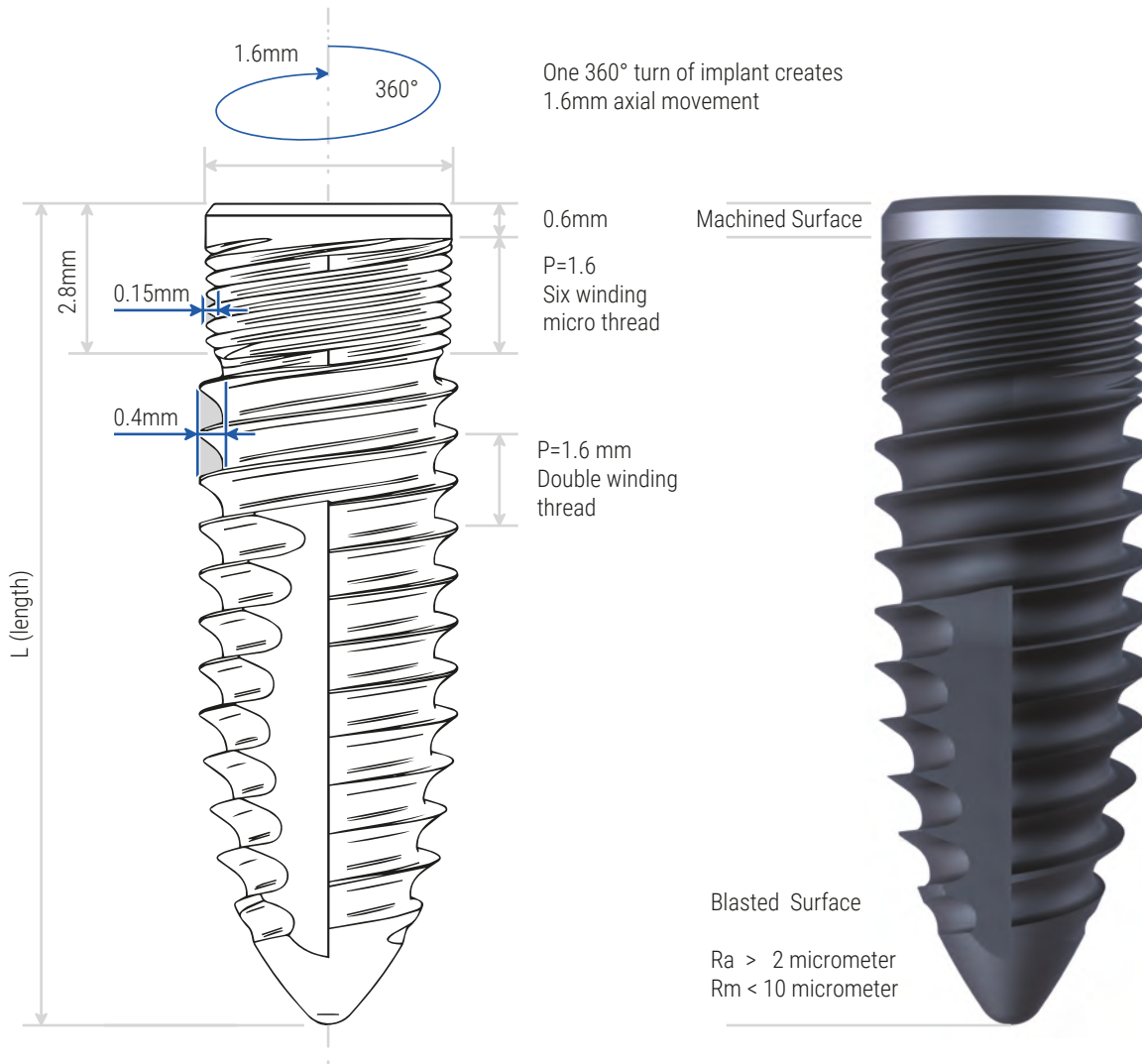

Surface Topography Modulates Osteoblast Morphology

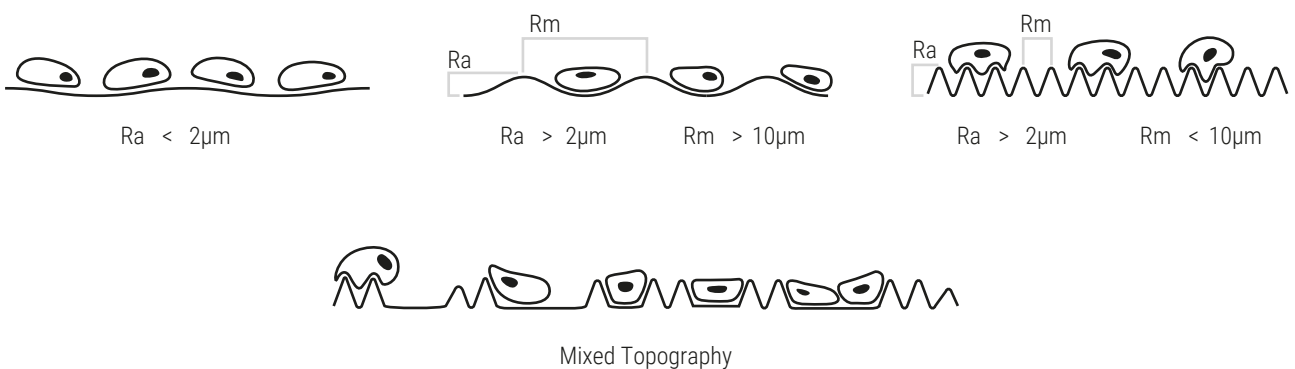

“Effect of surface topography on osteoblast morphology. When osteoblasts are cultured on a smooth surface ($Ra < 2\mu m$), they assume a flattened fibroblastic morphology. If they are cultured on surfaces with $Ra < 2\mu m$, but the distances between peaks (Rm) is greater than the length of the cell ($> 10\mu m$), the surface is perceived as smooth. If the Ra is $< 2\mu m$ and the Rm is $< 10\mu m$, the cells are unable to flatten and spread. They anchor to the surface via focal attachments by cytoplasmic extensions to multiple peaks. This forces the cell to assume a more osteoblastic morphology. On surfaces with mixed topography, the behaviour of the culture will reflect the average of the two morphologies.¹”

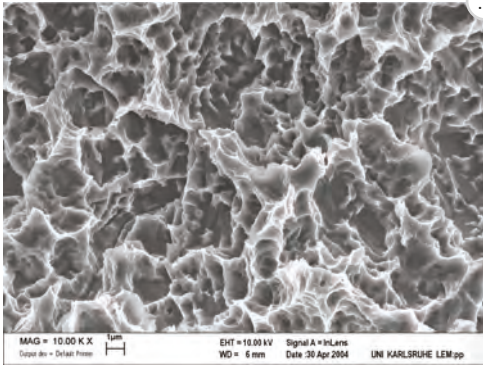

2 Surface Electron Microscope (SEM) study before insertion of implant, at 10,000x magnification.

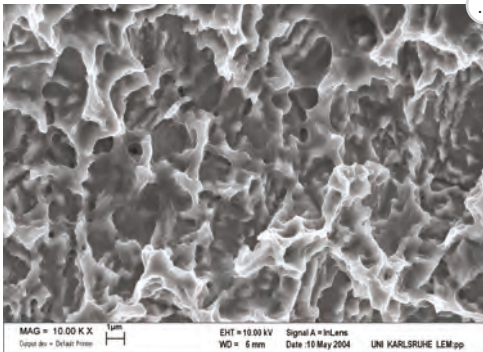

3 SEM study after insertion of implant in vitro into the bone, at 10,000x magnification. Topography of outer implant microstructure shows no friction forces on surface.

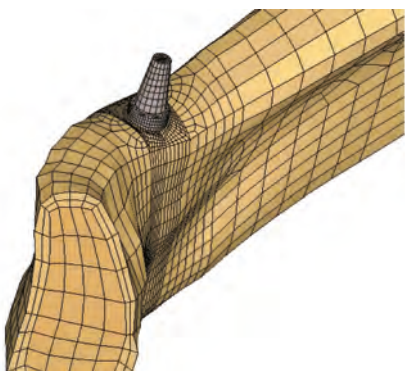

4 Finite Element Method (FEM) study of Q-Implant thread. Strain measured by various axial and lateral forces shows homogeneous stress in all bone-implant contact areas. No area extends 3,000 microstrains.

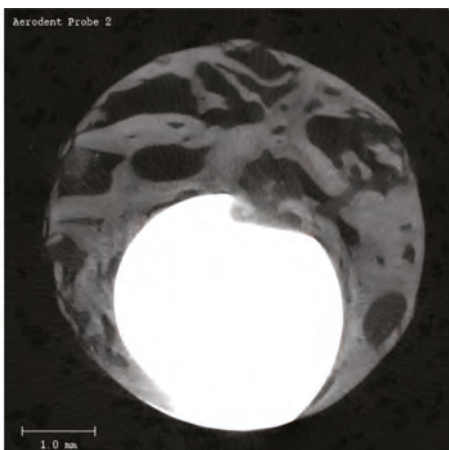

3 Micro CT scan (10 micron steps) of human prepare, 6 months post implant insertion, shows homogeneous bone-implant contact and advanced bone remodeling.

Literature:

1. B.D. Boyan and Z.Schwarz, Modulation of Osteogenesis via Implant Surface Design. Bone engineering, Toronto 2000, ISBN:096869800
2. TCP -Trinon Collegium Practicum, Volume XV-2004
3. Fraunhofer-Institut, Bremen, TCP- Trinon Collegium Practicum, Volume IX-2003
4. University of Karlsruhe, Poster presentation

Bibliography is available by manufacturer at trinon@trinon.com

One Screw size for all Platforms QZA0010



Abutment Platform Non Engaged (-NE)

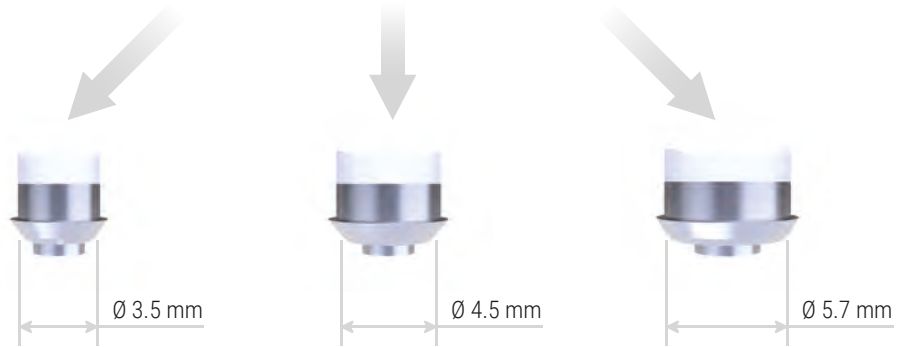

Abutment Platform Straight Hex Engaged (-E)

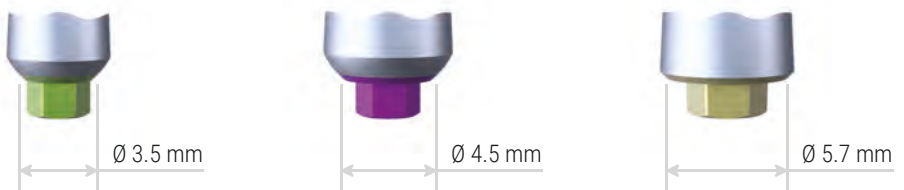

Abutment Platform Conical Hex Engaged (-E)

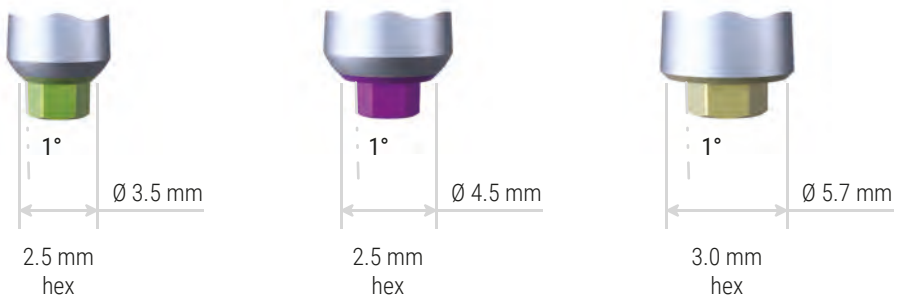



Implant Platform

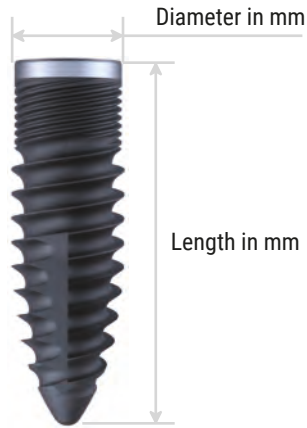

QZA-IMPLANTS & SURGICAL COMPONENTS



35 DIAMETER in mm	QZA PRODUCT ABBREVIATION	08 LENGTH in mm
--------------------------------	---------------------------------------	------------------------------

QZA-Implants						
Platform		Diameter	Length 8 mm	Length 10 mm	Length 12 mm	Length 14 mm
 3.5		Ø 3.3 mm	33QZA08	33QZA10	33QZA12	33QZA14
		Ø 3.5 mm	35QZA08	35QZA10	35QZA12	35QZA14
		Ø 3.8 mm	38QZA08	38QZA10	38QZA12	38QZA14
		Ø 4.2 mm	42QZA08	42QZA10	42QZA12	42QZA14
 4.5		Ø 4.5 mm	45QZA08	45QZA10	45QZA12	45QZA14
		Ø 4.8 mm	48QZA08	48QZA10	48QZA12	48QZA14
		Ø 5.4 mm	54QZA08	54QZA10	54QZA12	54QZA14
 5.7		Ø 5.7 mm	57QZA08	57QZA10	57QZA12	57QZA14

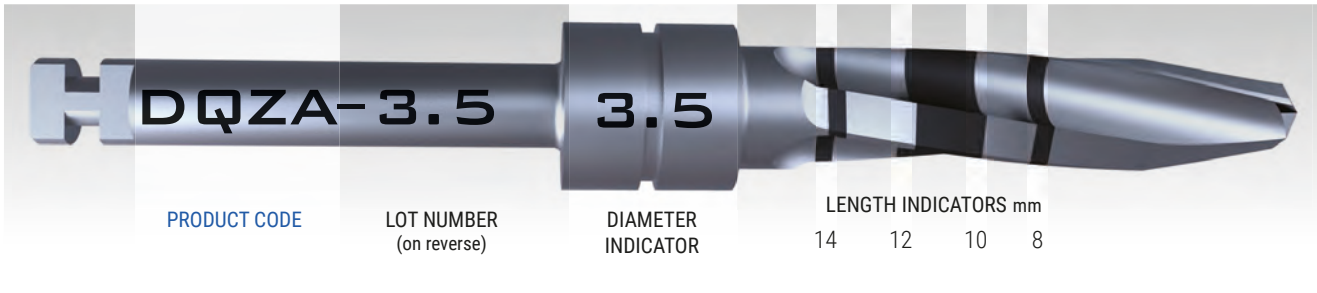

QZA-Implant Surgical Components

		Code	Diameter mm	For implants	
PILOT DRILL					
1		PDQ1	Ø 1.7	for all implants	
TROCAR DRILL					
2		DTZ.1-2.0	Ø 2.0	for all implants	
SHAPING DRILLS				standard for	cortical for
3		DQZA-3.0	Ø 3.0	3.3 mm implants	-
4		DQZA-3.3	Ø 3.3	3.5 mm implants	3.3 mm implants
5		DQZA-3.5	Ø 3.5	3.8 mm implants	3.5 mm implants
6		DQZA-3.8	Ø 3.8	4.2 mm implants	3.8 mm implants
7		DQZA-4.2	Ø 4.2	4.5 mm implants	4.2 mm implants
8		DQZA-4.5	Ø 4.5	4.8 mm implants	4.5 mm implants
9		DQZA-4.8	Ø 4.8	5.4 mm implants	4.8 mm implants
10		DQZA-5.4	Ø 5.4	5.7 mm implants	5.4 mm implants
11		DQZA-5.7	Ø 5.7	-	5.7 mm implants

Implant Drivers & Instruments

MECHANICAL IMPLANT DRIVER

19		Q2121	medium
20		Q2120	short

MANUAL IMPLANT DRIVER

24		Q2124	long
25		Q2123	short

INTERNAL MECHANICAL IMPLANT DRIVER

17		ITZ35L	long	for 3.5 mm and 4.5 mm platforms	
16		ITZ35S	short		
14		ITZ57L	long	for 5.7 mm platform	
15		ITZ57S	short		

DRIVER HANDLE FOR MANUAL IMPLANT DRIVER

18*	(image scaled)	DHQ1	*Replace QX30 and DHQ2
-----	----------------	------	------------------------

SCREWDRIVERS AND COMPONENTS

22		Q2114L	1.25 mm hex	L 30 mm
23		Q2114		L 20 mm
12		QX28	Drill extender	
13		Q2112	Screwdriver hand piece	
21		DHQ2	Ratchet connector for manual implant driver	

RATCHET

18	(image scaled)	QX30	Universal torque ratchet
----	----------------	------	--------------------------

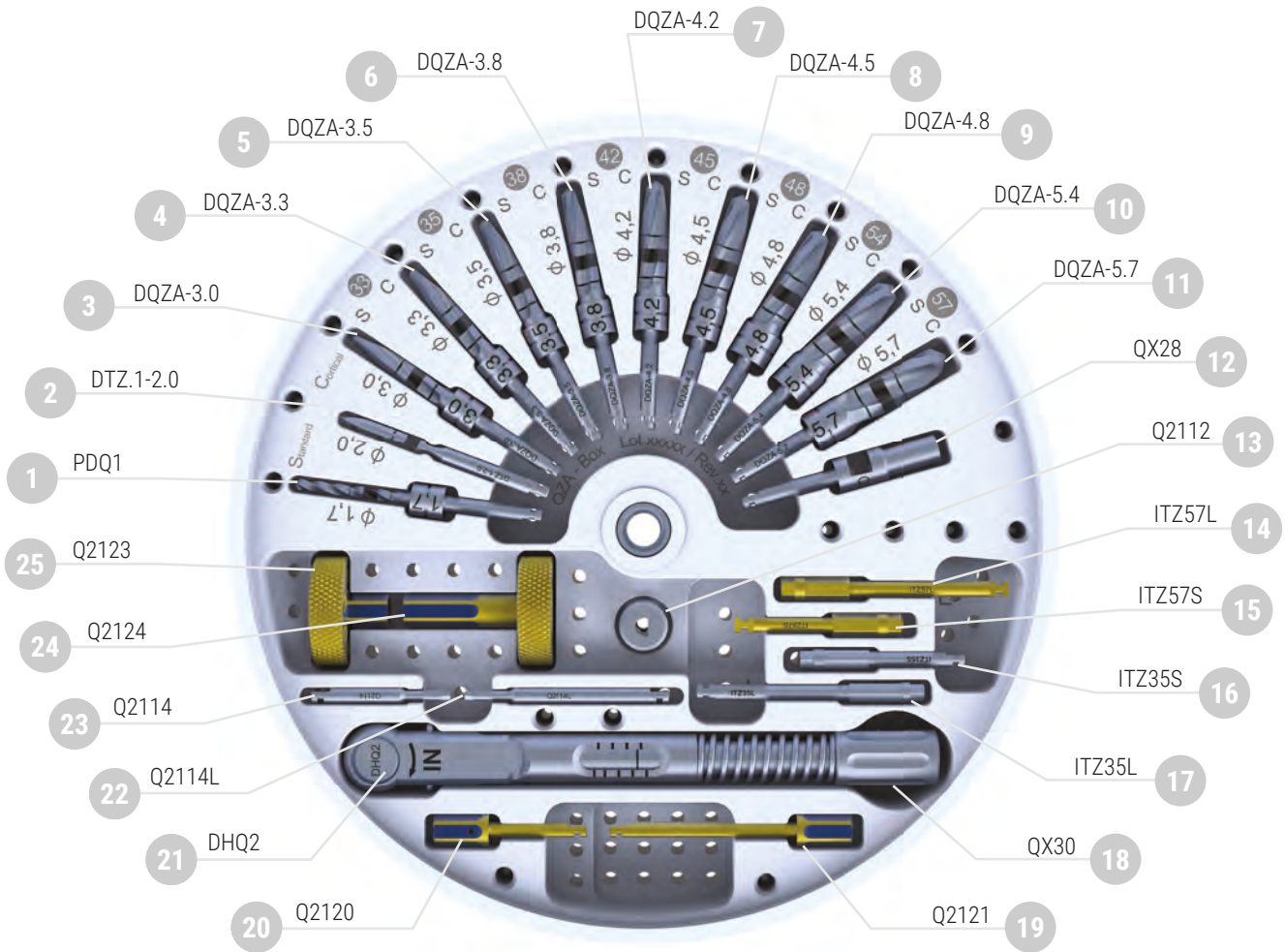

QZABOX01E	QZA Box without instruments
QZABOX01C	QZA Box with instruments (included QX30 and DHQ2)
QZABOX01C2	QZA Box with instruments (included DHQ1)

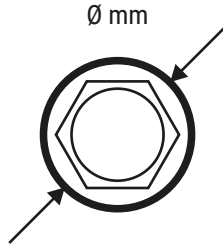
	QZA-IMPLANT Diameter							
	3.3	3.5	3.8	4.2	4.5	4.8	5.4	5.7
Standard Drill Ø mm	3.0	3.3	3.5	3.8	4.2	4.5	4.8	5.4
Cortical Drill Ø mm	3.3	3.5	3.8	4.2	4.5	4.8	5.4	5.7

– "Cut preparation time in half by placing necessary drills upright prior to surgery"

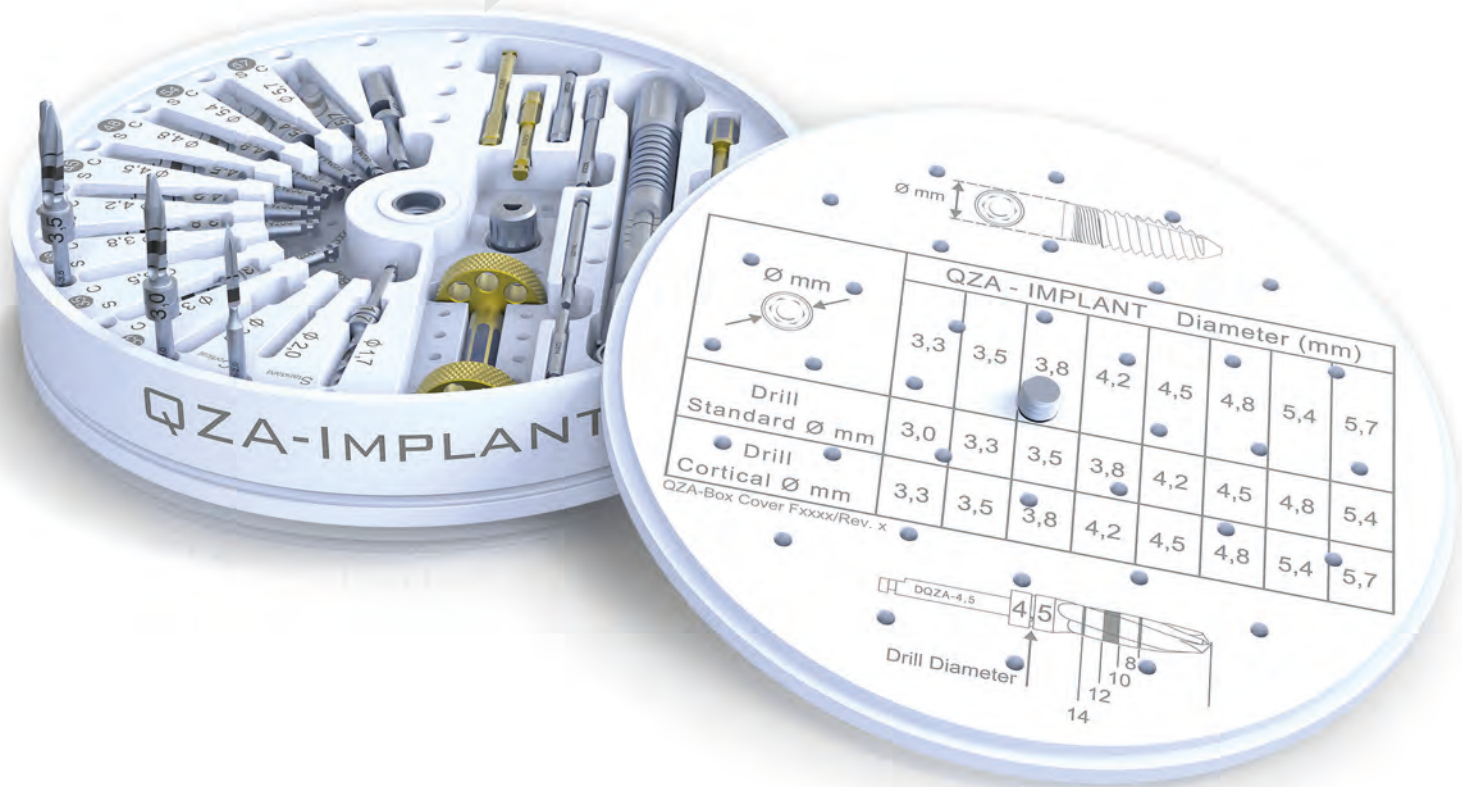

– "Simple and compact surgical kit includes drilling instructions on lid"

Q-Implant Drill Stop Kit

	STP-SET	Drill stop kit with 32 stoppers
	STP-BOX	Empty box for drill stoppers

Stopper Sizes

Drill Diameter	Length 8 mm		Length 10 mm		Length 12 mm		Length 14 mm	
≤ 4.5 mm		ASTP08		ASTP10		ASTP12		ASTP14
≥ 4.8 mm		BSTP08		BSTP10		BSTP12		BSTP14

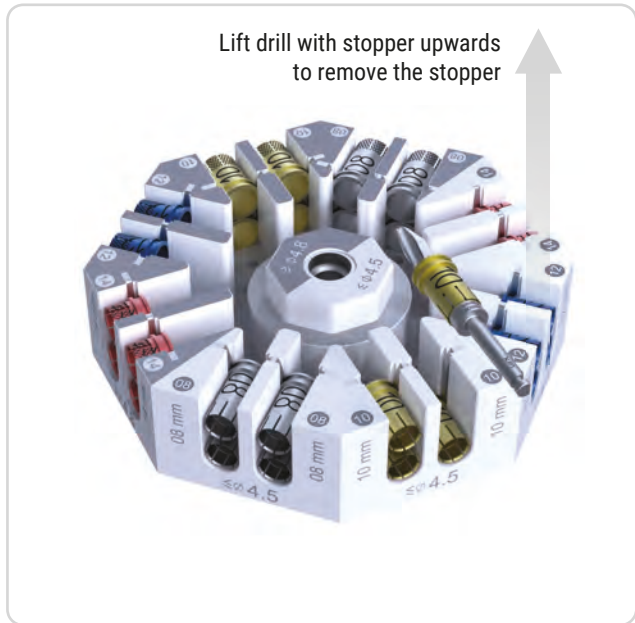
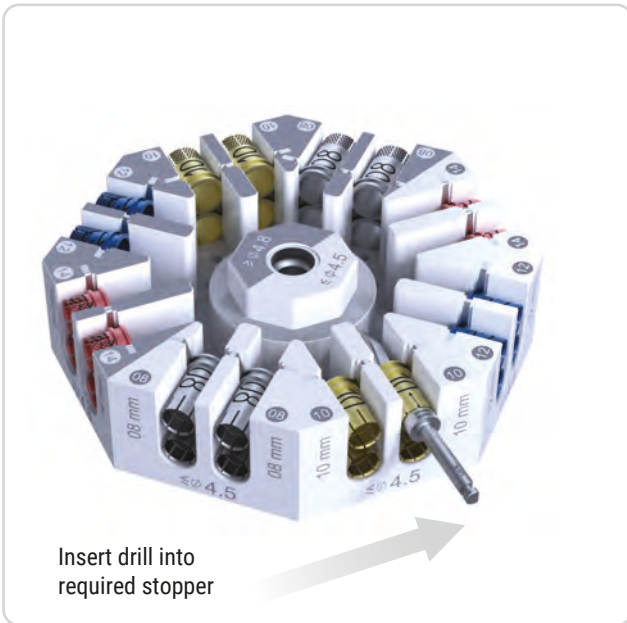

To return the stopper to the kit, simply reverse the procedure

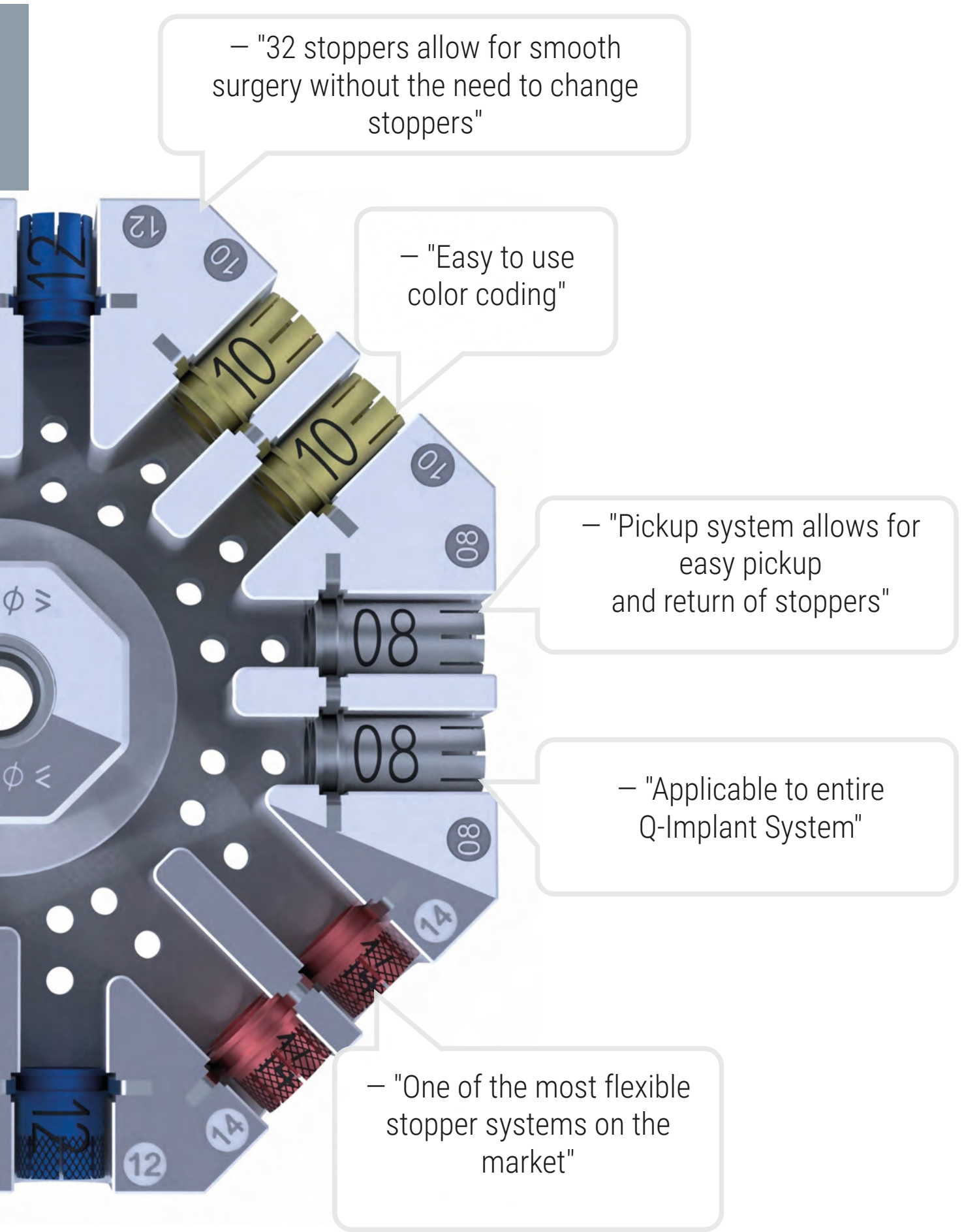

SURGICAL PROTOCOLS

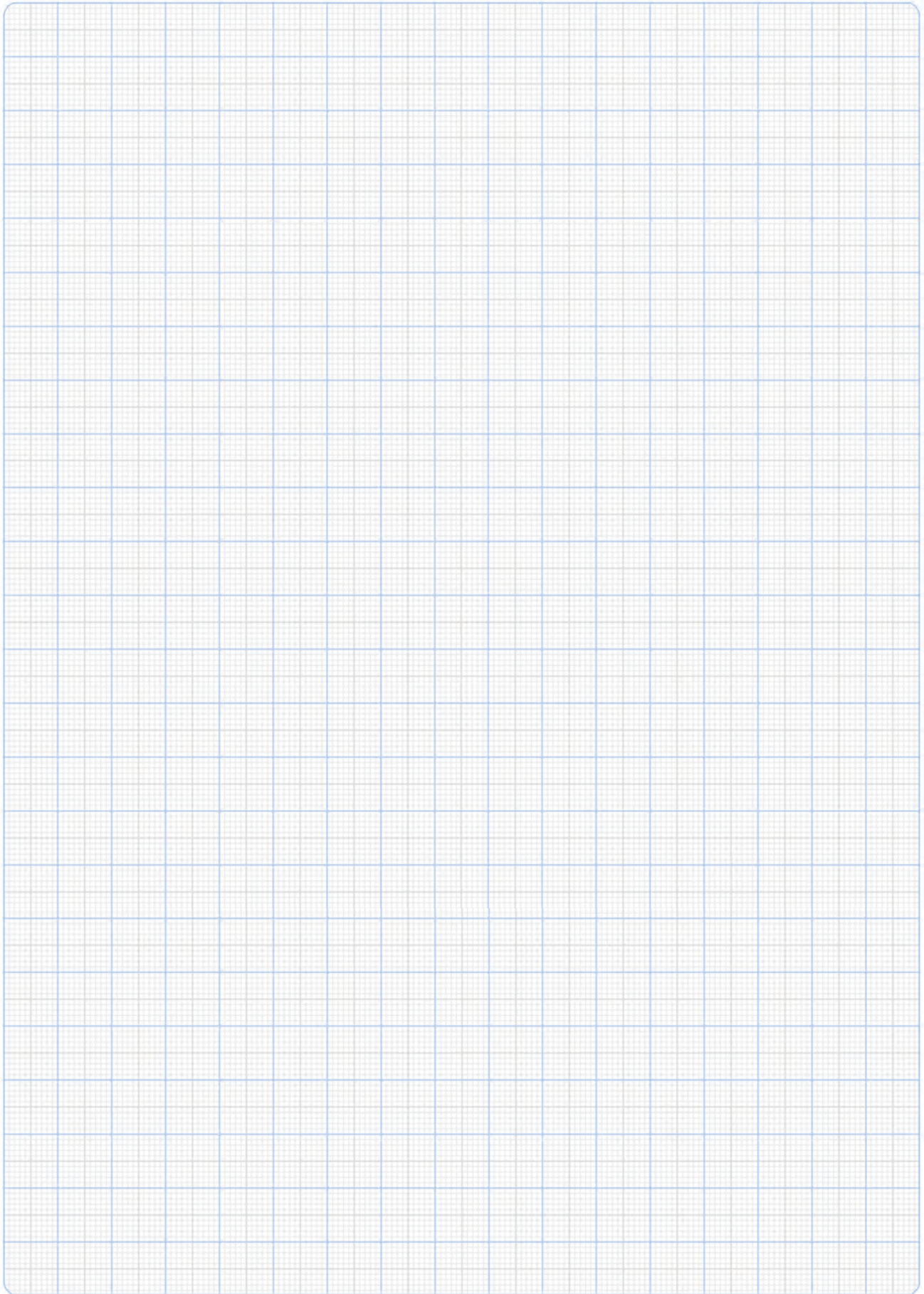

ALL QZA Drills

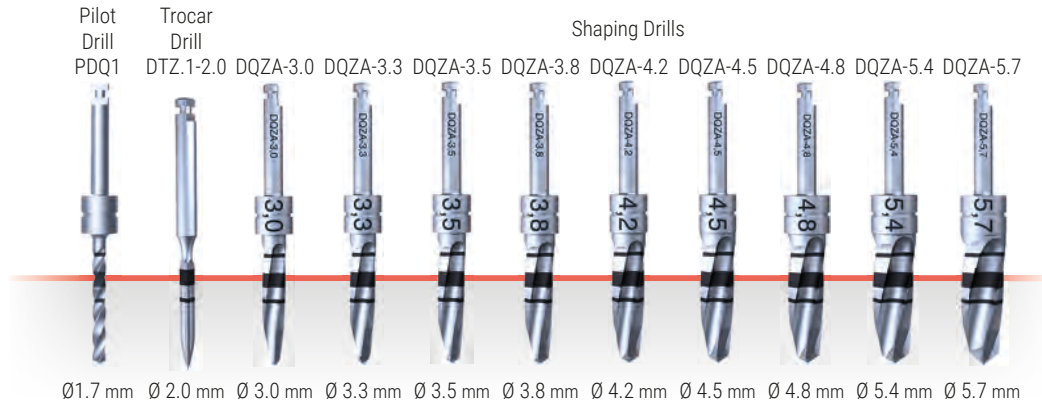

SURGICAL PROTOCOLS

Implant diameter mm

	Trocar drill or pilot drill	DQZA-3.0	DQZA-3.3	DQZA-3.5	DQZA-3.8	DQZA-4.2	DQZA-4.5	DQZA-4.8	DQZA-5.4	DQZA-5.7
Ø 3.3	1	2	3							
Ø 3.5	1	2	3	4						
Ø 3.8	1	2	X	3	4					
Ø 4.2	1	2	X	X	3	4				
Ø 4.5	1	2	X	X	3	4	5			
Ø 4.8	1	2	X	X	3	X	4	5		
Ø 5.4	1	2	X	X	3	X	4	5	6	
Ø 5.7	1	2	X	X	3	X	4	5	6	7

OPTIONAL: Cortical drill in D1 quality bone.

NOTE: Use of Q-Osteotomes to compress and condense Type D4 quality bone, is recommended.

ALL QZA Drills

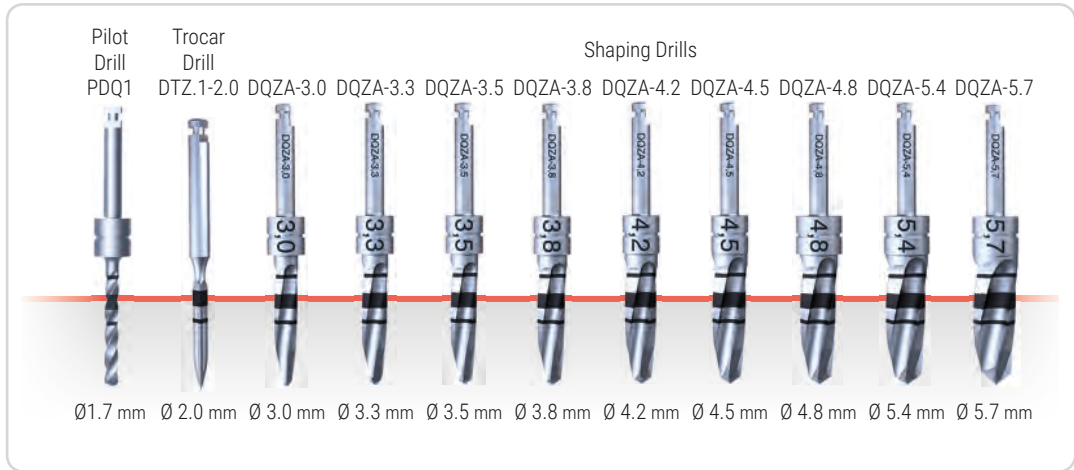

Implant Ø 3.3 mm



- 1 Trocar drill or pilot drill
- 2 Shaping drill - use of stopper recommended

3
OPTIONAL: Cortical drill
in D1 quality bone

Implant Ø 3.5 mm

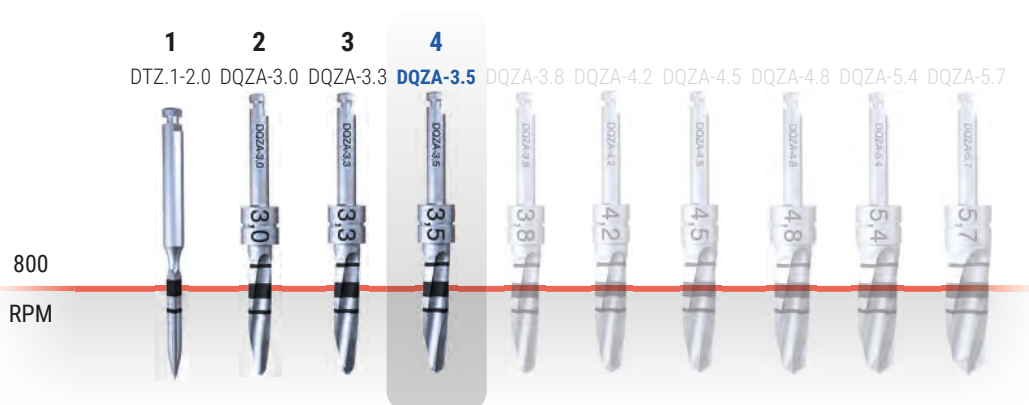

- 1 Trocar drill or pilot drill
- 2 Shaping drill - use of stopper recommended
- 3 Shaping drill – in D4/D3 bone quality use as last drill

4
OPTIONAL: Cortical drill
in D1 quality bone

ALL QZA Drills

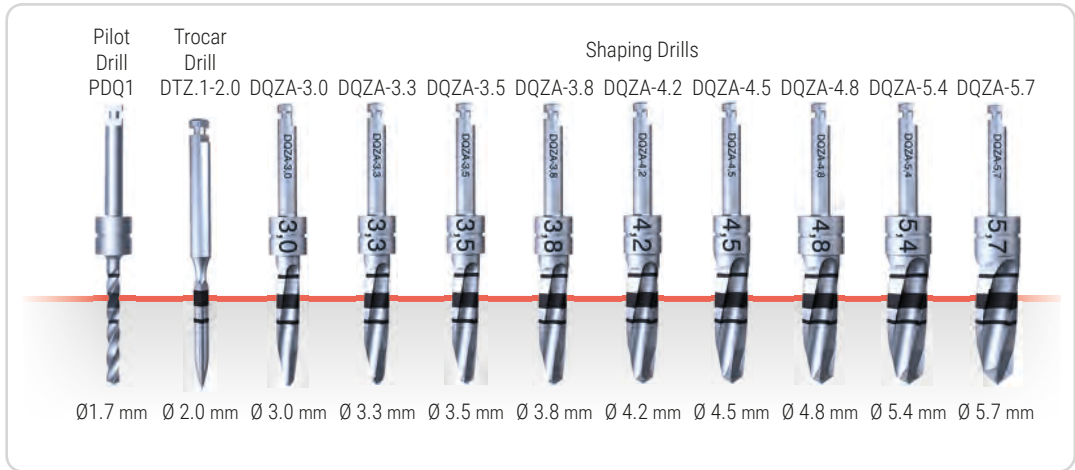

**Implant
Ø 3.8 mm**



3.5 platform

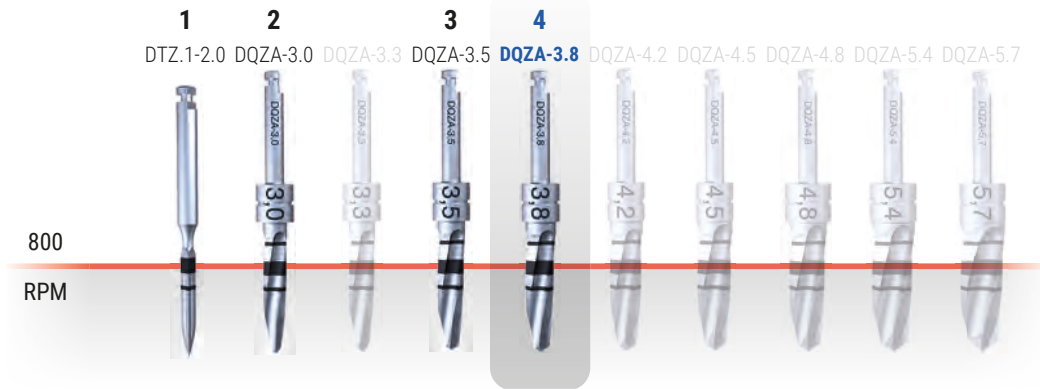

- 1 Trocar drill or pilot drill
- 2 Shaping drill - use of stopper recommended
- 3 Shaping drill – in D4/D3 bone quality use as last drill

4
**OPTIONAL: Cortical drill
in D1 quality bone**

**Implant
Ø 4.2 mm**



3.5 platform

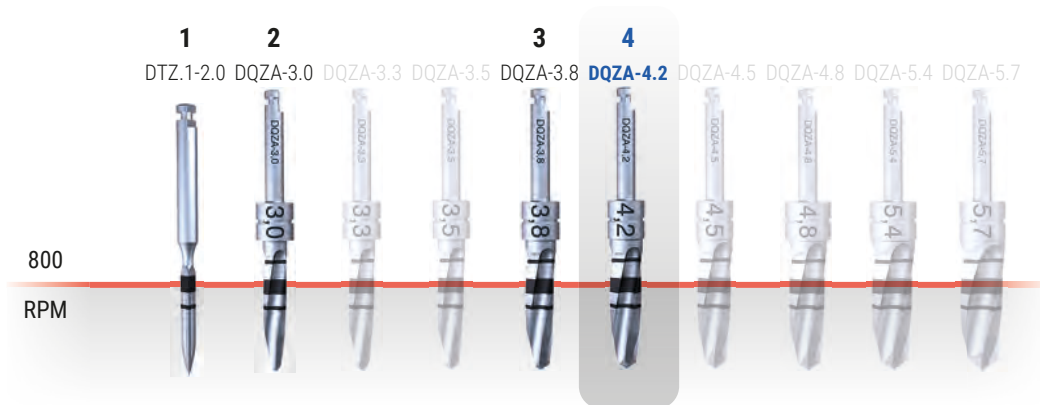

- 1 Trocar drill or pilot drill
- 2 Shaping drill - use of stopper recommended
- 3 Shaping drill – in D4/D3 bone quality use as last drill

4
**OPTIONAL: Cortical drill
in D1 quality bone**

ALL QZA Drills

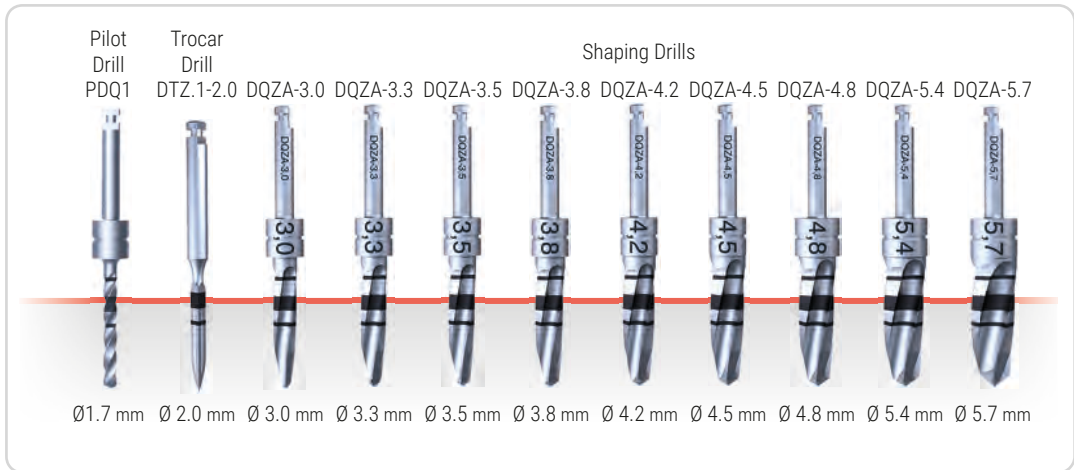

Implant Ø 4.5 mm

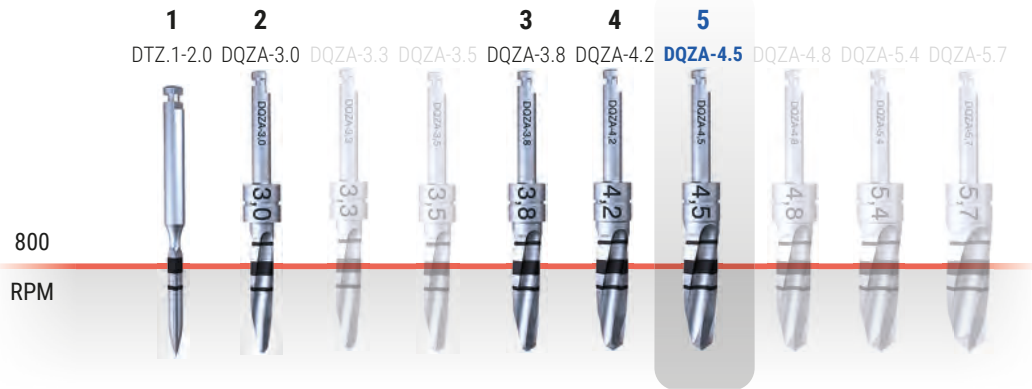

- 1 Trocar drill or pilot drill
- 2-3 Shaping drill - use of stopper recommended
- 4 Shaping drill – in D4/D3 bone quality use as last drill

5
OPTIONAL: Cortical drill
in D1 quality bone

Implant Ø 4.8 mm

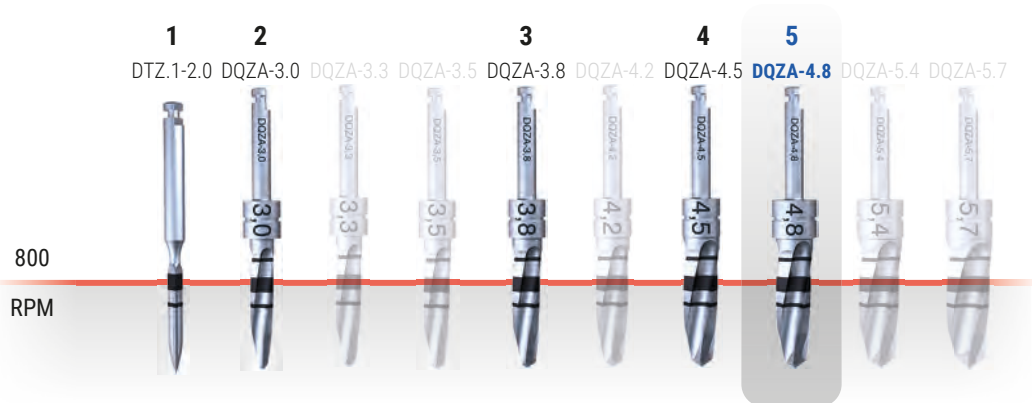

- 1 Trocar drill or pilot drill
- 2-3 Shaping drill - use of stopper recommended
- 4 Shaping drill – in D4/D3 bone quality use as last drill

5
OPTIONAL: Cortical drill
in D1 quality bone

ALL QZA Drills

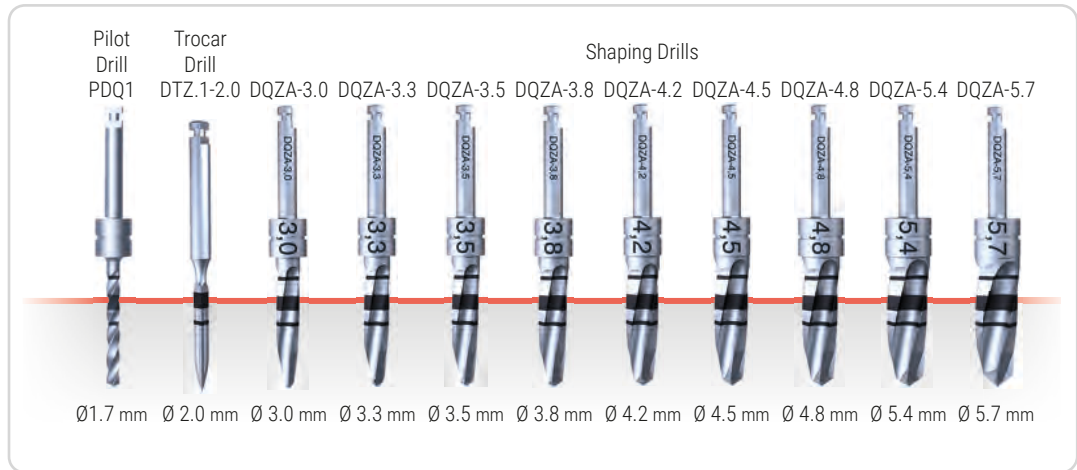

SURGICAL PROTOCOLS

**Implant
Ø 5.4 mm**



4.5 platform

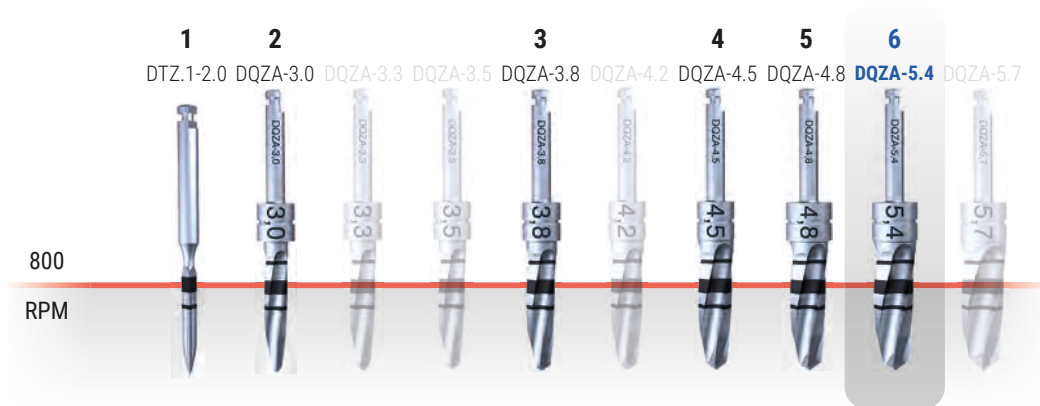

- 1 Trocar drill or pilot drill
- 2-4 Shaping drill - use of stopper recommended
- 5 Shaping drill – in D4/D3 bone quality use as last drill

6
OPTIONAL: Cortical drill
in D1 quality bone

**Implant
Ø 5.7 mm**



5.7 platform

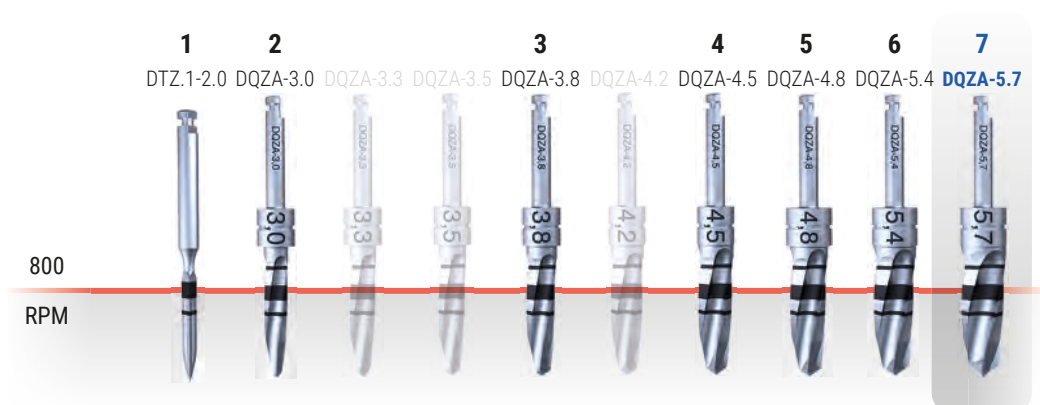

- 1 Trocar drill or pilot drill
- 2-5 Shaping drill - use of stopper recommended
- 6 Shaping drill – in D4/D3 bone quality use as last drill

7
OPTIONAL: Cortical drill
in D1 quality bone

QZA-Implant Insertion

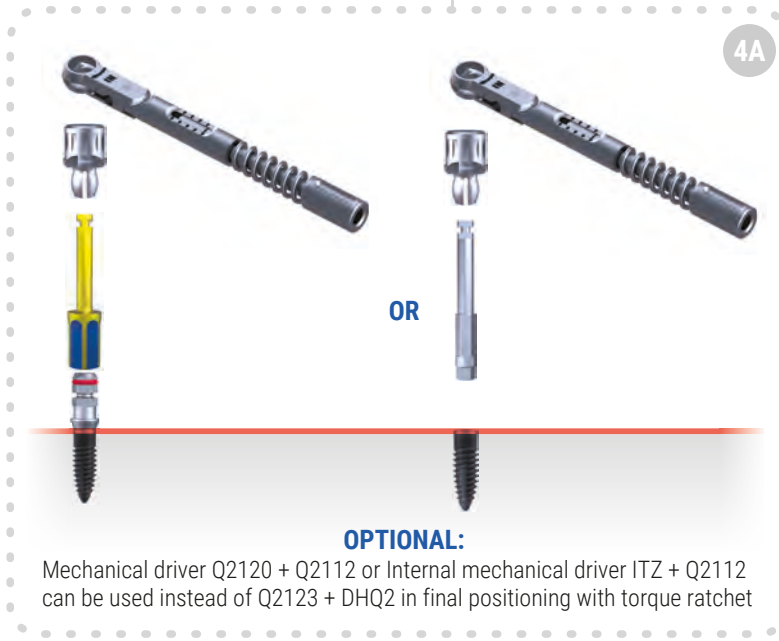
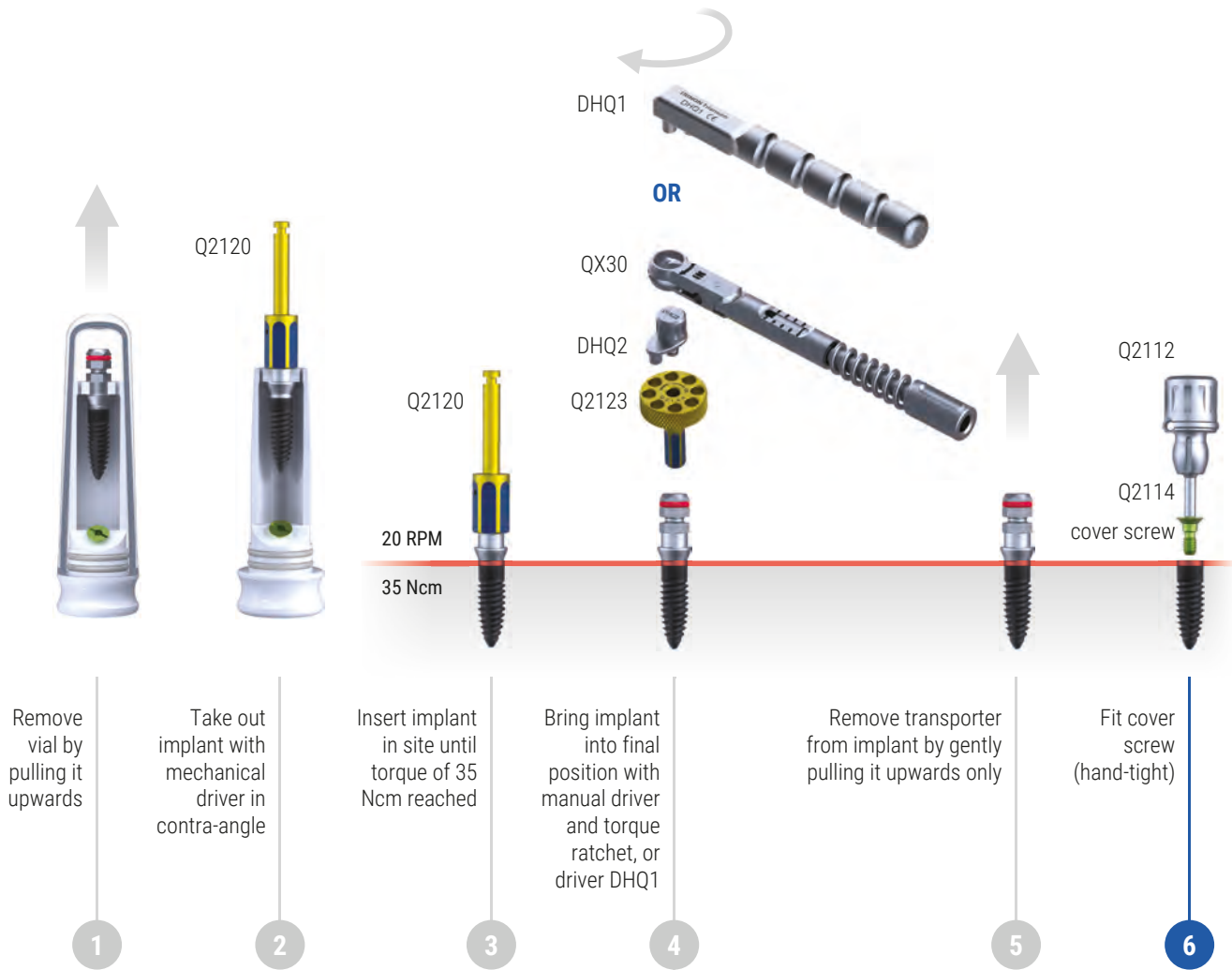

NOTE: Once machine stops at 35Ncm do not continue inserting implant by hand with contra-angle. Use manual driver only.

Removal of Implant from Packaging and Location of Cover Screw

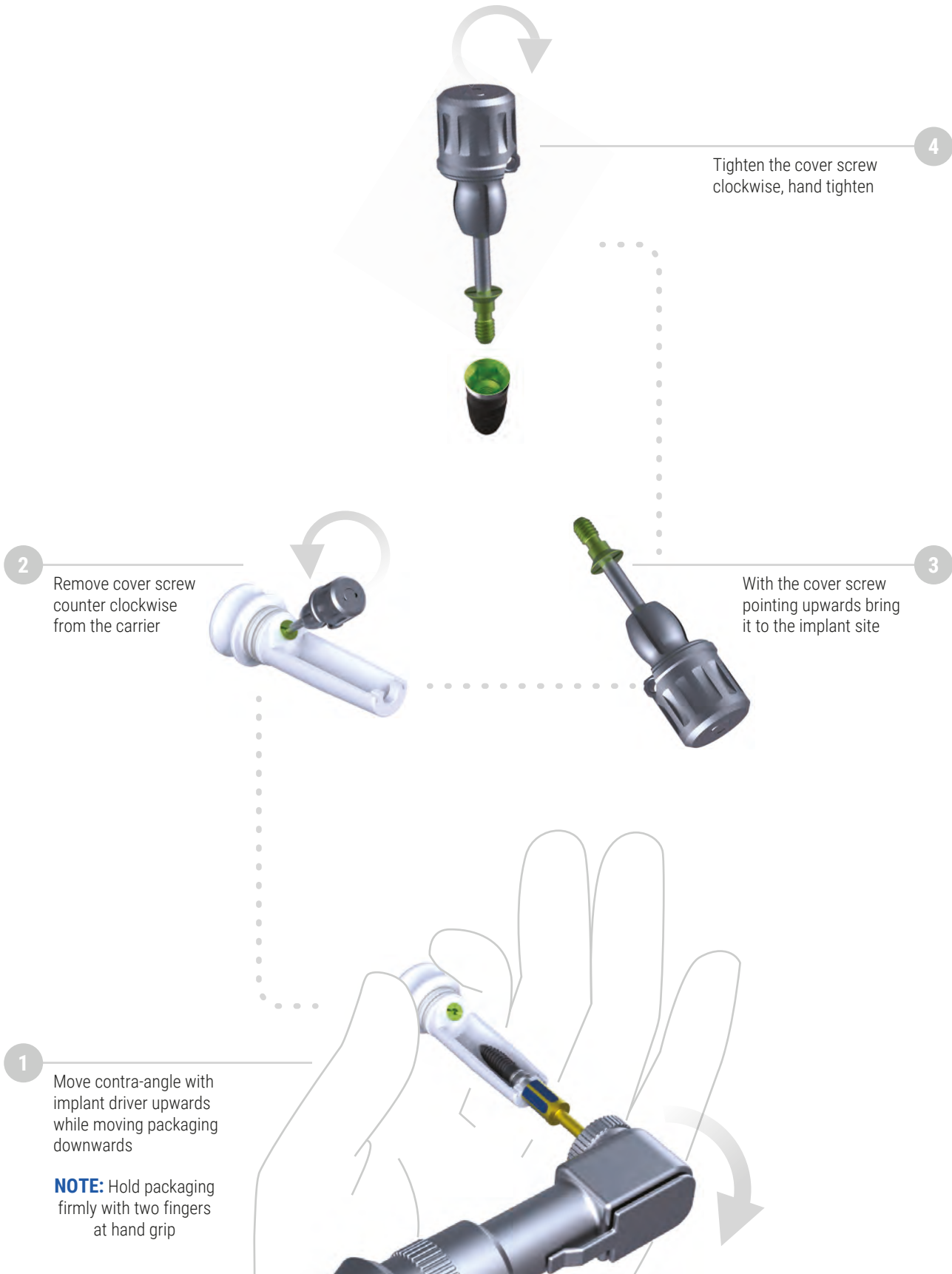



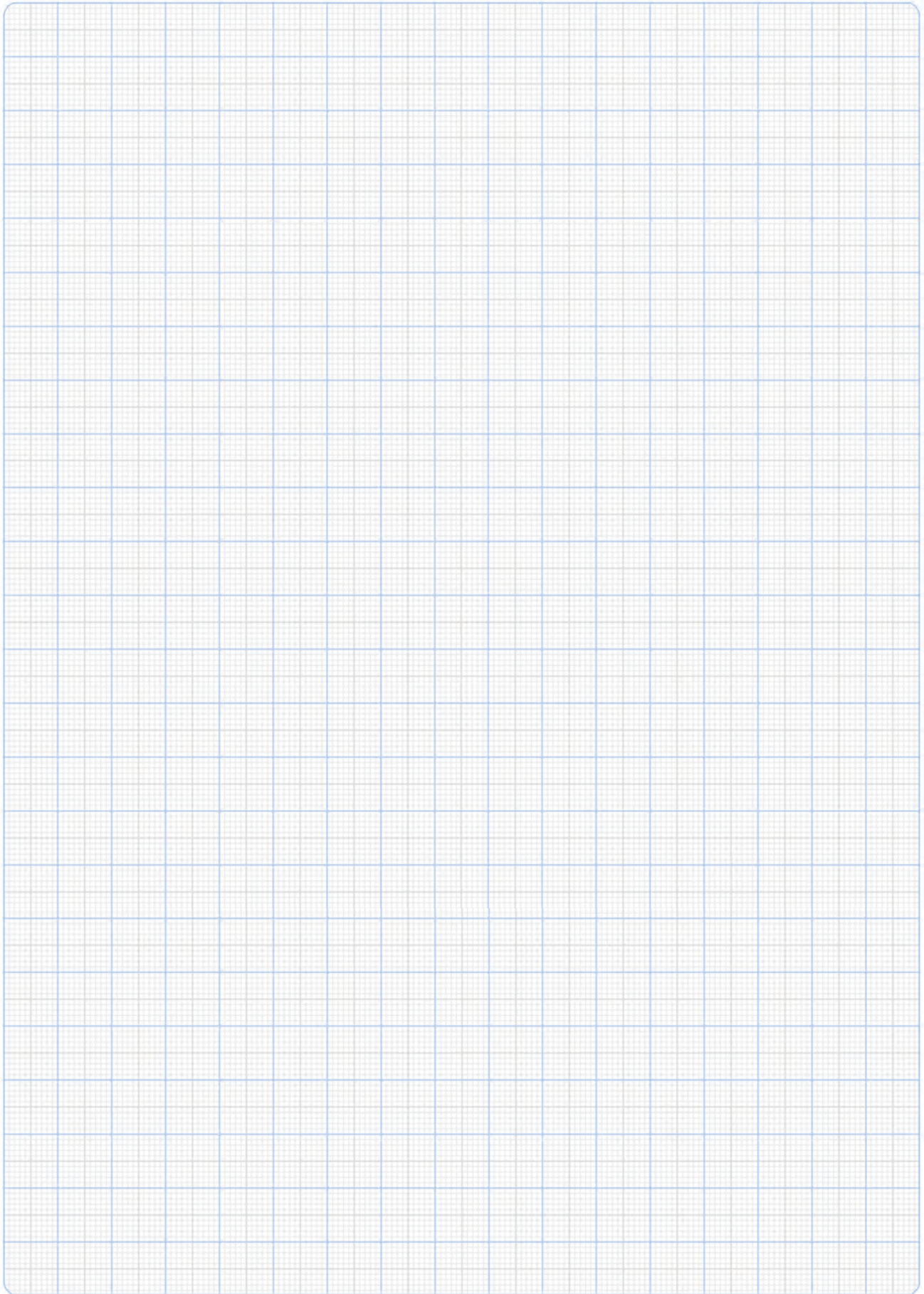

SURGICAL PROTOCOLS



PROSTHETIC COMPONENTS

Overview

on pages			on pages		
29		ILZ Impression Components	29		IOZ Impression Components
32		LABZ Laboratory Components	33		HAZ Healing Abutments
34		TTZ Temporary Abutments	35		UPZ UCLA Abutments Plastic
36		UMZ UCLA Abutments on Semi-Precious Metal	37		TBZ Titanium Base Abutments
38		ACZ Q-Cone Abutments	40		ASZ Straight Abutments
41		AAZ Angled Abutments	44		HLZ Preparable (HLA) Abutments
45		ABZ Q-Ball Abutments	49		ALZ Q-Lock Abutments
52		AMZ Multi-Unit Abutments	53		AMZ Multi-Unit Abutments Angled

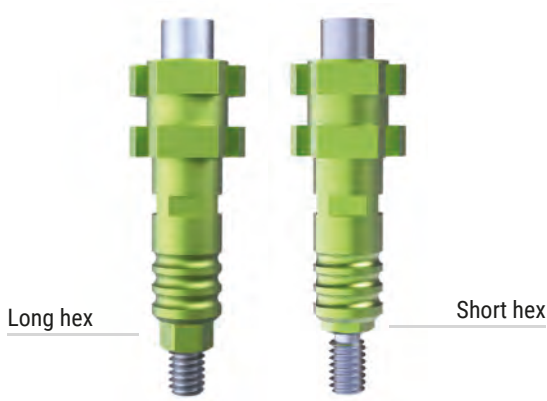

35 PLATFORM INDICATOR	ILZ PRODUCT ABBREVIATION	- S HEX INDICATOR
------------------------------------	---------------------------------------	--------------------------------

Impression Components

	IMPRESSION POST WITH SCREW	Code		Platform	
Open tray		35ILZ-S	Short hex	3.5 mm	
		45ILZ-S		4.5 mm	
		57ILZ-S		5.7 mm	
	Closed tray		35ILZ-L	Long hex	3.5 mm
			45ILZ-L		4.5 mm
			57ILZ-L		5.7 mm
Closed tray		35IOZ-B		3.5 mm	
		45IOZ-B		4.5 mm	
		57IOZ-B		5.7 mm	

PROSTHETIC
COMPONENTS

NOTE: For crown restoration with open tray technique, use ILZ post with long hex. For bridge restoration, use ILZ post with short hex.

Impression-Taking Flow Chart Implant Level Impression Closed Tray Technique

Chairside











Impression-Taking Flow Chart Implant Level Impression Open Tray Technique





PROSTHETIC
COMPONENTS

Laboratory Components

	LAB ANALOG	Code	For implants
3.5		33LABZ	Ø 3.3 mm
		35LABZ	Ø 3.5 mm
		38LABZ	Ø 3.8 mm
		42LABZ	Ø 4.2 mm
4.5		45LABZ	Ø 4.5 mm
		48LABZ	Ø 4.8 mm
		54LABZ	Ø 5.4 mm
5.7		57LABZ	Ø 5.7 mm





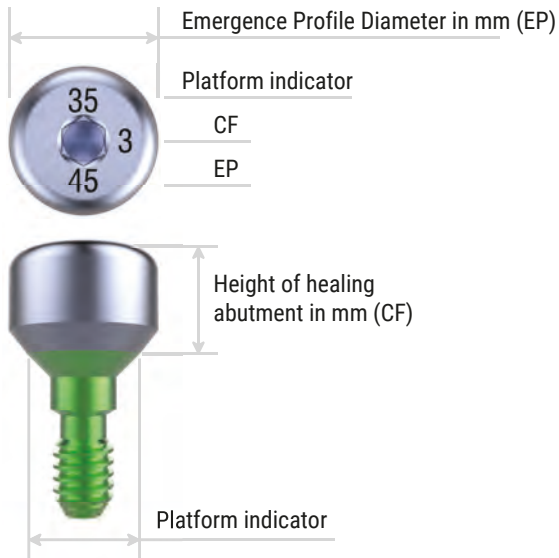

Additional Screws (included with abutments)

	QZA0010	Abutment fixing screw	
	QZA0011		low head for angulated abutment only
	QZA0013	Abutment lifting screw	long



35 PLATFORM INDICATOR	HAZ PRODUCT ABBREVIATION	45 EP INDICATOR	- 3 CF INDICATOR
---------------------------------	------------------------------------	---------------------------	----------------------------

Healing Abutments





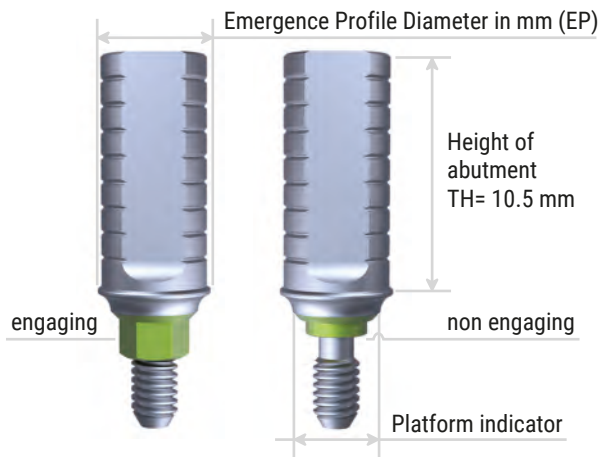

			CF 3	CF 5	CF 7
 3.5		EP 3.5	35HAZ35-3	35HAZ35-5	
		EP 3.8	35HAZ38-3	35HAZ38-5	
		EP 4.2	35HAZ42-3	35HAZ42-5	35HAZ42-7
		EP 4.5	35HAZ45-3	35HAZ45-5	35HAZ45-7
		EP 5.5	35HAZ55-3	35HAZ55-5	35HAZ55-7
 4.5		EP 4.5	45HAZ45-3	45HAZ45-5	
		EP 4.8	45HAZ48-3	45HAZ48-5	
		EP 5.5	45HAZ55-3	45HAZ55-5	45HAZ55-7
		EP 6.5	45HAZ65-3	45HAZ65-5	
 5.7		EP 5.7	57HAZ57-3	57HAZ57-5	
		EP 6.5	57HAZ65-3	57HAZ65-5	

PROSTHETIC COMPONENTS



35	TTZ	45	-E
PLATFORM INDICATOR	PRODUCT ABBREVIATION	EP INDICATOR	ENGAGING INDICATOR

Temporary Abutments (Titanium)

		engaging (crown)	non engaging (bridge)
 3.5	EP 3.5		35TTZ35-E
	EP 4.5		35TTZ45-E
	EP 5.5		35TTZ55-E
 4.5	EP 4.5		45TTZ45-E
	EP 5.5		45TTZ55-E
	EP 6.5		45TTZ65-E
 5.7	EP 6.5		57TTZ65-E

Abutment Screw

	QZA0010	Abutment fixing screw
---	---------	-----------------------

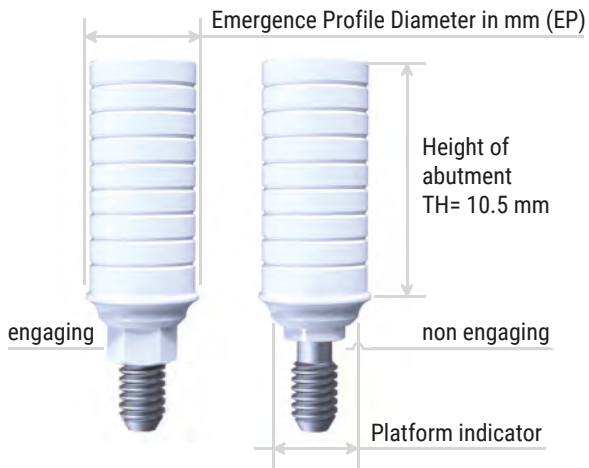

35	UPZ	45	-E
PLATFORM INDICATOR	PRODUCT ABBREVIATION	EP INDICATOR	ENGAGING INDICATOR

UCLA Abutments Plastic with Titanium Screw

		engaging (crown)	non engaging (bridge)		
 3.5	EP 3.5		35UPZ35-E		35UPZ35-NE
	EP 4.5		35UPZ45-E		35UPZ45-NE
	EP 5.5		35UPZ55-E		35UPZ55-NE
 4.5	EP 4.5		45UPZ45-E		45UPZ45-NE
	EP 5.5		45UPZ55-E		45UPZ55-NE
	EP 6.5		45UPZ65-E		45UPZ65-NE
 5.7	EP 6.5		57UPZ65-E		57UPZ65-NE

PROSTHETIC COMPONENTS

Abutment Screw

	QZA0010	Abutment fixing screw
--	---------	-----------------------

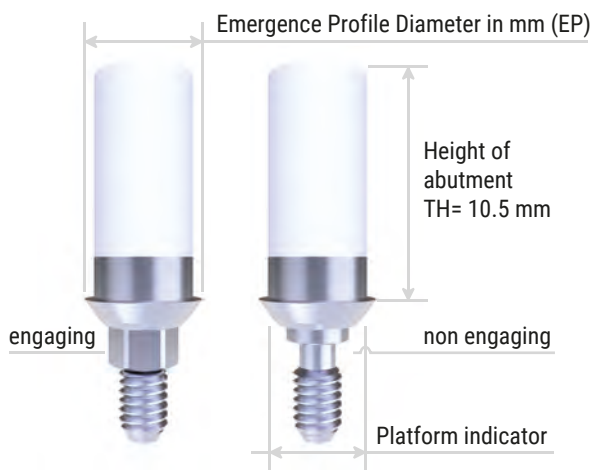

35	UMZ	45-E
PLATFORM INDICATOR	PRODUCT ABBREVIATION	EP INDICATOR
		ENGAGING INDICATOR

UCLA Abutments on Semi-Precious Metal

	engaging (crown)		non engaging (bridge)	
3.5		35UMZ45-E		35UMZ45-NE
4.5		45UMZ55-E		45UMZ55-NE
5.7		57UMZ65-E		57UMZ65-NE

Abutment Screw

	QZA0010	Abutment fixing screw
--	---------	-----------------------

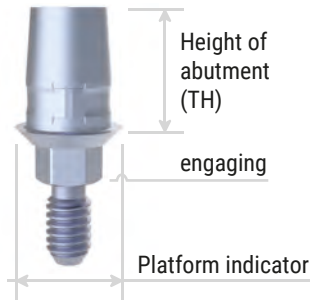

35	TBZ	- A
PLATFORM INDICATOR	PRODUCT ABBREVIATION	TYPE INDICATOR

Titanium Base Abutments

 3.5		35TBZ-A
 4.5		45TBZ-A
 5.7		57TBZ-A

PROSTHETIC
COMPONENTS

Scan Cap

	TBZ-ACAP
---	----------

Abutment Screw

	QZA0010	Abutment fixing screw
---	---------	--------------------------

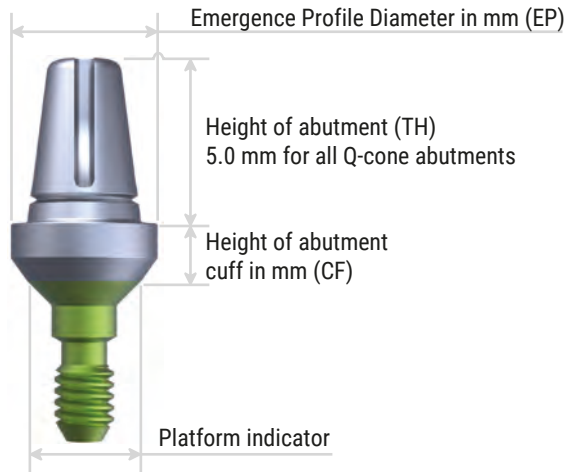

35	ACZ	45	-3
PLATFORM INDICATOR	PRODUCT ABBREVIATION	EP INDICATOR	CF INDICATOR

Q-Cone Abutments

			CF 0.75	CF 2.00	CF 3.00	CF 4.00
 3.5		EP 3.5	35ACZ35-1	35ACZ35-2	35ACZ35-3	35ACZ35-4
		EP 4.5	35ACZ45-1	35ACZ45-2	35ACZ45-3	35ACZ45-4
		EP 5.5	35ACZ55-1	35ACZ55-2	35ACZ55-3	35ACZ55-4
 4.5		EP 4.5	45ACZ45-1	45ACZ45-2	45ACZ45-3	45ACZ45-4
		EP 5.5	45ACZ55-1	45ACZ55-2	45ACZ55-3	45ACZ55-4
		EP 6.5	45ACZ65-1	45ACZ65-2	45ACZ65-3	45ACZ65-4
 5.7		EP 6.5	57ACZ65-1	57ACZ65-2	57ACZ65-3	57ACZ65-4

Healing Caps for Q-Cone Abutments

Q-CONE HEALING CAP

	Q5002	medium
	Q5003	large

Fixation Drivers for Q-Cone Abutments

MECHANICAL IMPLANT DRIVER

	IKQ3	
--	------	--

MANUAL IMPLANT DRIVER

	IWQS	short
	IWQL	long

Impression-Taking Flow Chart Abutment Level (Q-Cone Bridge Only)

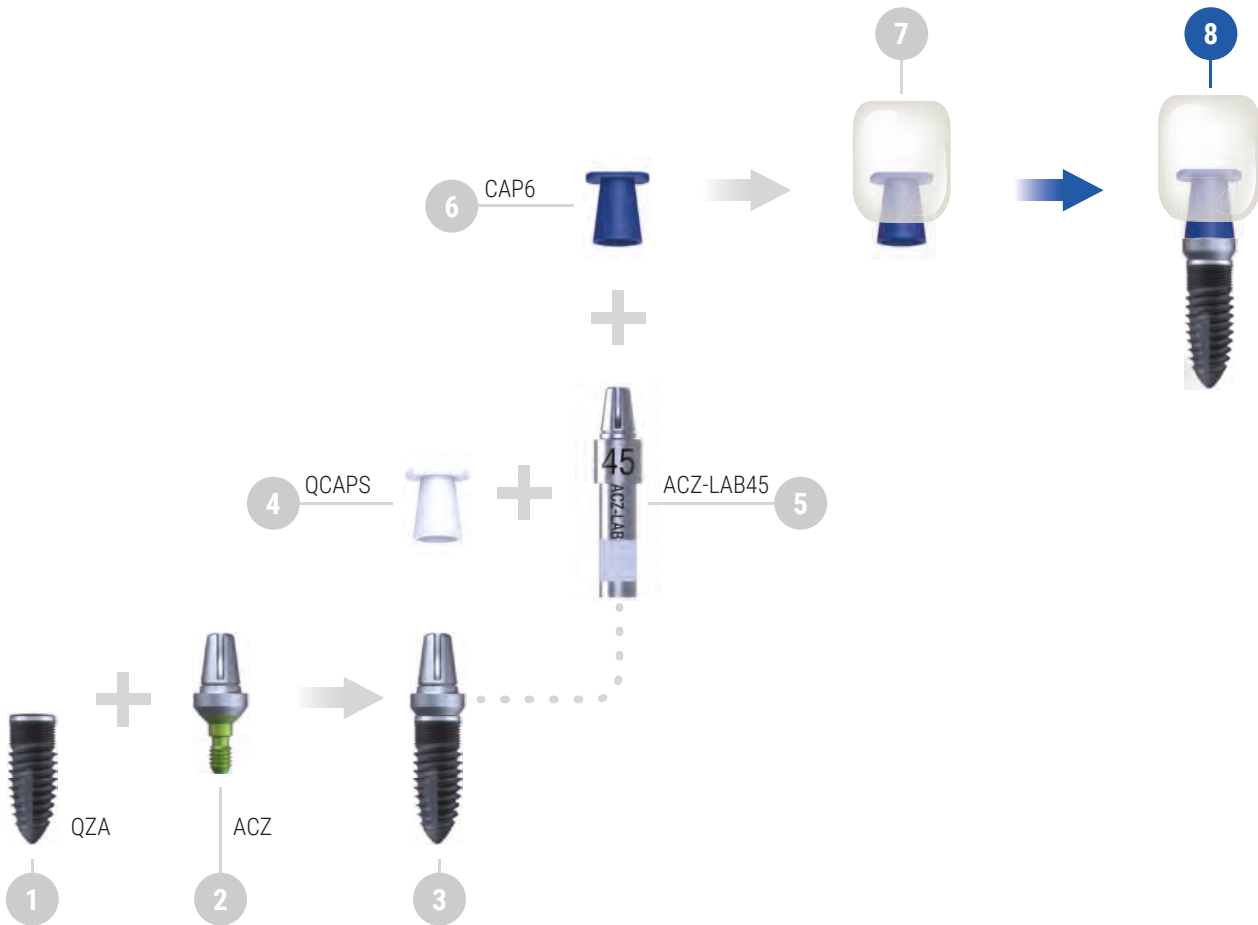

PROSTHETIC COMPONENTS

NOTE: Example for ACZ abutment with platform 3,5 mm and EP 4,5 mm. For additional component numbers, please refer to product catalog.

Impression and Laboratory Components

IMPRESSION CAP FOR Q-CONE ABUTMENTS

	QCAPS	non-engaging (bridge)	Closed tray	all platforms
--	-------	-----------------------	-------------	---------------

CAP FOR CASTING FOR Q-CONE ABUTMENTS

	CAP6	non-engaging (bridge)		
--	------	-----------------------	--	--





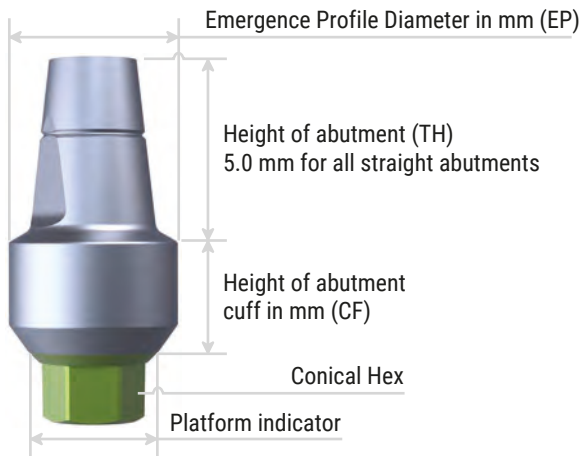

LABORATORY ANALOG FOR Q-CONE ABUTMENTS

	ACZ-LAB35		ACZ-LAB55
	ACZ-LAB45		ACZ-LAB65



NOTE: For optimal results choose EP size of laboratory analog same as EP size of abutment. Impression caps can also be used for immediate temporary restoration, such as an acrylic bridge, prepared chairside by utilizing a wax-up technique.



Straight Abutments

			CF 0.75	CF 2.00	CF 3.00	CF 4.00
 3.5		EP 3.3	35ASZ33-1	35ASZ33-2	35ASZ33-3	35ASZ33-4
		EP 3.5	35ASZ35-1	35ASZ35-2	35ASZ35-3	35ASZ35-4
		EP 4.5	35ASZ45-1	35ASZ45-2	35ASZ45-3	35ASZ45-4
		EP 5.5	35ASZ55-1	35ASZ55-2	35ASZ55-3	35ASZ55-4
 4.5		EP 4.5	45ASZ45-1	45ASZ45-2	45ASZ45-3	45ASZ45-4
		EP 4.8	45ASZ48-1	45ASZ48-2	45ASZ48-3	45ASZ48-4
		EP 5.5	45ASZ55-1	45ASZ55-2	45ASZ55-3	45ASZ55-4
		EP 6.5	45ASZ65-1	45ASZ65-2	45ASZ65-3	45ASZ65-4
 5.7		EP 5.7	57ASZ57-1	57ASZ57-2	57ASZ57-3	57ASZ57-4
		EP 6.5	57ASZ65-1	57ASZ65-2	57ASZ65-3	57ASZ65-4

Abutment Screws

	QZA0010	Abutment fixing screw
	QZA0013	Abutment lifting screw

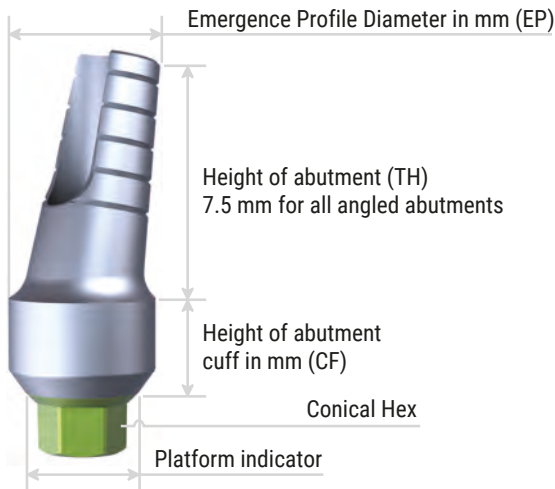

35	AAZ	45	.1	- 10
PLATFORM INDICATOR	PRODUCT ABBREVIATION	EP INDICATOR	CF INDICATOR	ANGULATION INDICATOR

10° Angled Abutments

			CF 0.75	CF 2.00
 3.5		EP 3.3	35AAZ33.1-10	35AAZ33.2-10
		EP 3.5	35AAZ35.1-10	35AAZ35.2-10
		EP 4.5	35AAZ45.1-10	35AAZ45.2-10
		EP 5.5	35AAZ55.1-10	35AAZ55.2-10
 4.5		EP 4.5	45AAZ45.1-10	45AAZ45.2-10
		EP 4.8	45AAZ48.1-10	45AAZ48.2-10
		EP 5.5	45AAZ55.1-10	45AAZ55.2-10
		EP 6.5	45AAZ65.1-10	45AAZ65.2-10
 5.7		EP 5.7	57AAZ57.1-10	57AAZ57.2-10
		EP 6.5	57AAZ65.1-10	57AAZ65.2-10

PROSTHETIC COMPONENTS





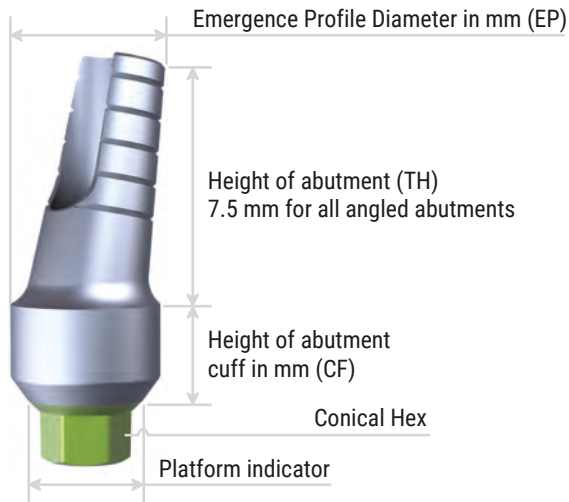

Abutment Screws

	QZA0010	Abutment fixing screw
	QZA0011	
	QZA0013	Abutment lifting screw





35	AAZ	45	.1	-15
PLATFORM INDICATOR	PRODUCT ABBREVIATION	EP INDICATOR	CF INDICATOR	ANGULATION INDICATOR

15° Angled Abutments

			CF 0.75	CF 2.00
 3.5		EP 3.3	35AAZ33.1-15	35AAZ33.2-15
		EP 3.5	35AAZ35.1-15	35AAZ35.2-15
		EP 4.5	35AAZ45.1-15	35AAZ45.2-15
		EP 5.5	35AAZ55.1-15	35AAZ55.2-15
 4.5		EP 4.5	45AAZ45.1-15	45AAZ45.2-15
		EP 4.8	45AAZ48.1-15	45AAZ48.2-15
		EP 5.5	45AAZ55.1-15	45AAZ55.2-15
		EP 6.5	45AAZ65.1-15	45AAZ65.2-15
 5.7		EP 5.7	57AAZ57.1-15	57AAZ57.2-15
		EP 6.5	57AAZ65.1-15	57AAZ65.2-15

Abutment Screws

	QZA0010	Abutment fixing screw	
	QZA0011		low head for CF 0.75
	QZA0013	Abutment lifting screw	

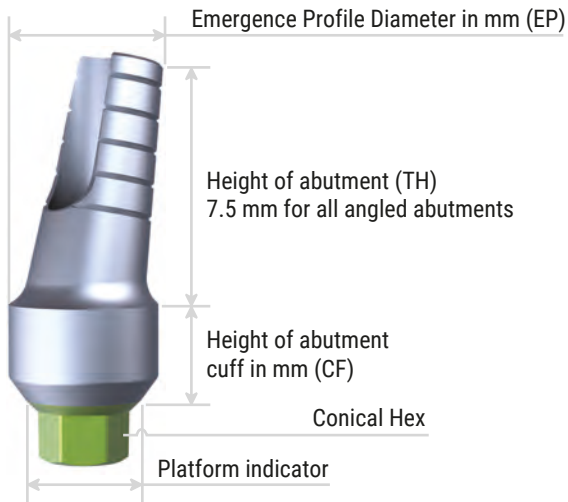

35	AAZ	45	.1	-20
PLATFORM INDICATOR	PRODUCT ABBREVIATION	EP INDICATOR	CF INDICATOR	ANGULATION INDICATOR

20° Angled Abutments

			CF 0.75	CF 2.00
 3.5		EP 3.3	35AAZ33.1-20	35AAZ33.2-20
		EP 3.5	35AAZ35.1-20	35AAZ35.2-20
		EP 4.5	35AAZ45.1-20	35AAZ45.2-20
		EP 5.5	35AAZ55.1-20	35AAZ55.2-20
 4.5		EP 4.5	45AAZ45.1-20	45AAZ45.2-20
		EP 4.8	45AAZ48.1-20	45AAZ48.2-20
		EP 5.5	45AAZ55.1-20	45AAZ55.2-20
		EP 6.5	45AAZ65.1-20	45AAZ65.2-20
 5.7		EP 5.7	57AAZ57.1-20	57AAZ57.2-20
		EP 6.5	57AAZ65.1-20	57AAZ65.2-20

PROSTHETIC COMPONENTS





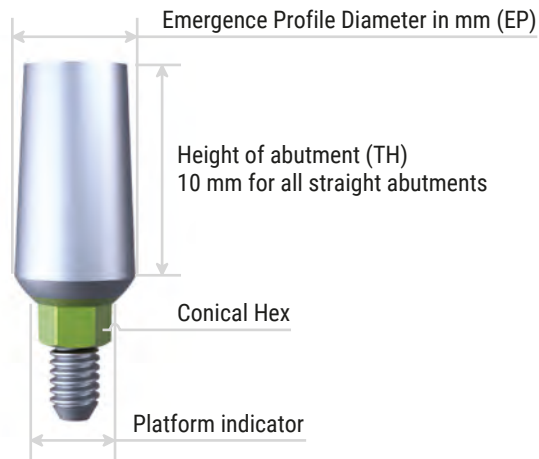

Abutment Screws

	QZA0010	Abutment fixing screw
	QZA0011	
	QZA0013	Abutment lifting screw





35	HLZ	45
PLATFORM INDICATOR	PRODUCT ABBREVIATION	EP INDICATOR

Preparable (HLA) Abutments

 3.5		EP 3.5	35HLZ35
		EP 4.5	35HLZ45
		EP 5.5	35HLZ55
 4.5		EP 4.5	45HLZ45
		EP 5.5	45HLZ55
		EP 6.5	45HLZ65
 5.7		EP 5.7	57HLZ57
		EP 6.5	57HLZ65

Abutment Screws

	QZA0010	Abutment fixing screw
	QZA0013	Abutment lifting screw

Q-Ball Overdenture Restoration Flow Chart

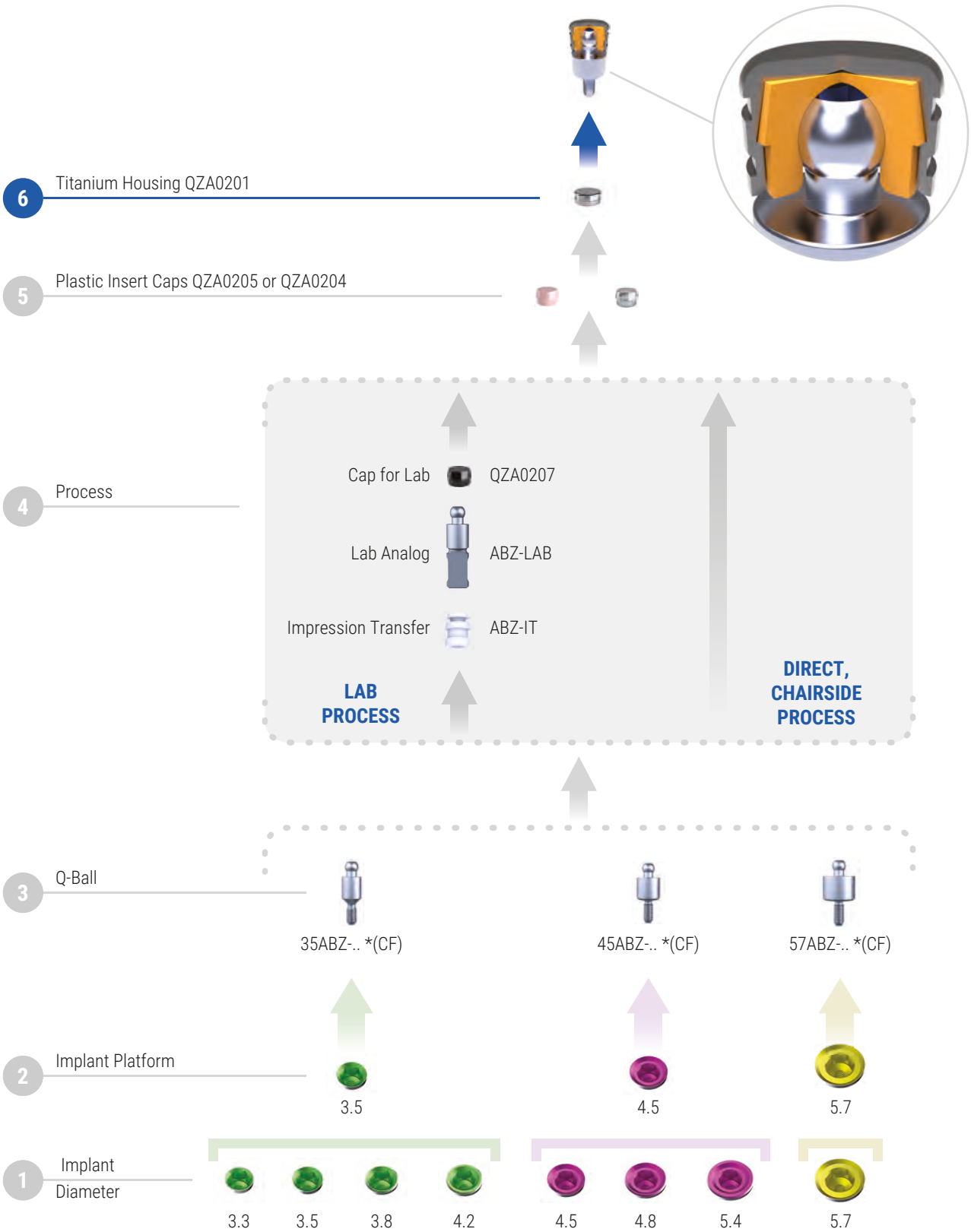

PROSTHETIC COMPONENTS

*(CF) - see page 46

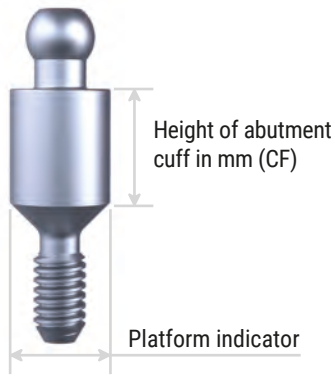

35 ABZ - 3

PLATFORM INDICATOR PRODUCT ABBREVIATION CF INDICATOR

Q-Ball Abutments

	1	CF 1.00	CF 2.00	CF 3.00	CF 4.00	CF 5.00	CF 6.00
3.5		35ABZ-1	35ABZ-2	35ABZ-3	35ABZ-4	35ABZ-5	35ABZ-6
4.5		45ABZ-1	45ABZ-2	45ABZ-3	45ABZ-4	45ABZ-5	45ABZ-6
5.7		57ABZ-1	57ABZ-2	57ABZ-3	57ABZ-4	57ABZ-5	57ABZ-6



45 ABZ - 3 - SET

PLATFORM INDICATOR PRODUCT ABBREVIATION CF INDICATOR SET INDICATOR

Q-Ball Set Included Items



- 3 Housing for caps
QZA0201
- 2 Plastic insert caps
QZA0205
QZA0204
- 1 Q-Ball Abutment
..ABZ-

Q-Ball Abutment Instruments and Components

INSERTION/ EXTRACTION TOOL FOR PLASTIC CAPS

 (image scaled)	ALZ-002		
--	---------	--	--

SCREWDRIVER

	Q2114	1.25 mm hex	L 20 mm
	Q2114L		L 30 mm

IMPRESSION TRANSFER

	ABZ-IT		
---	--------	--	--

LAB ANALOG

	ABZ-LAB		
---	---------	--	--



HOUSING FOR Q-BALL CAPS (TITANIUM)

3 	QZA0201		
--	---------	--	--

PLASTIC INSERT CAP FOR LAB USE

 (black)	QZA0207		
---	---------	--	--

PLASTIC INSERT CAPS

2  (pink)	QZA0205	medium	1.98 lb / 900G
 (clear)	QZA0204	strong	2.87 lb / 1300G

PROSTHETIC COMPONENTS

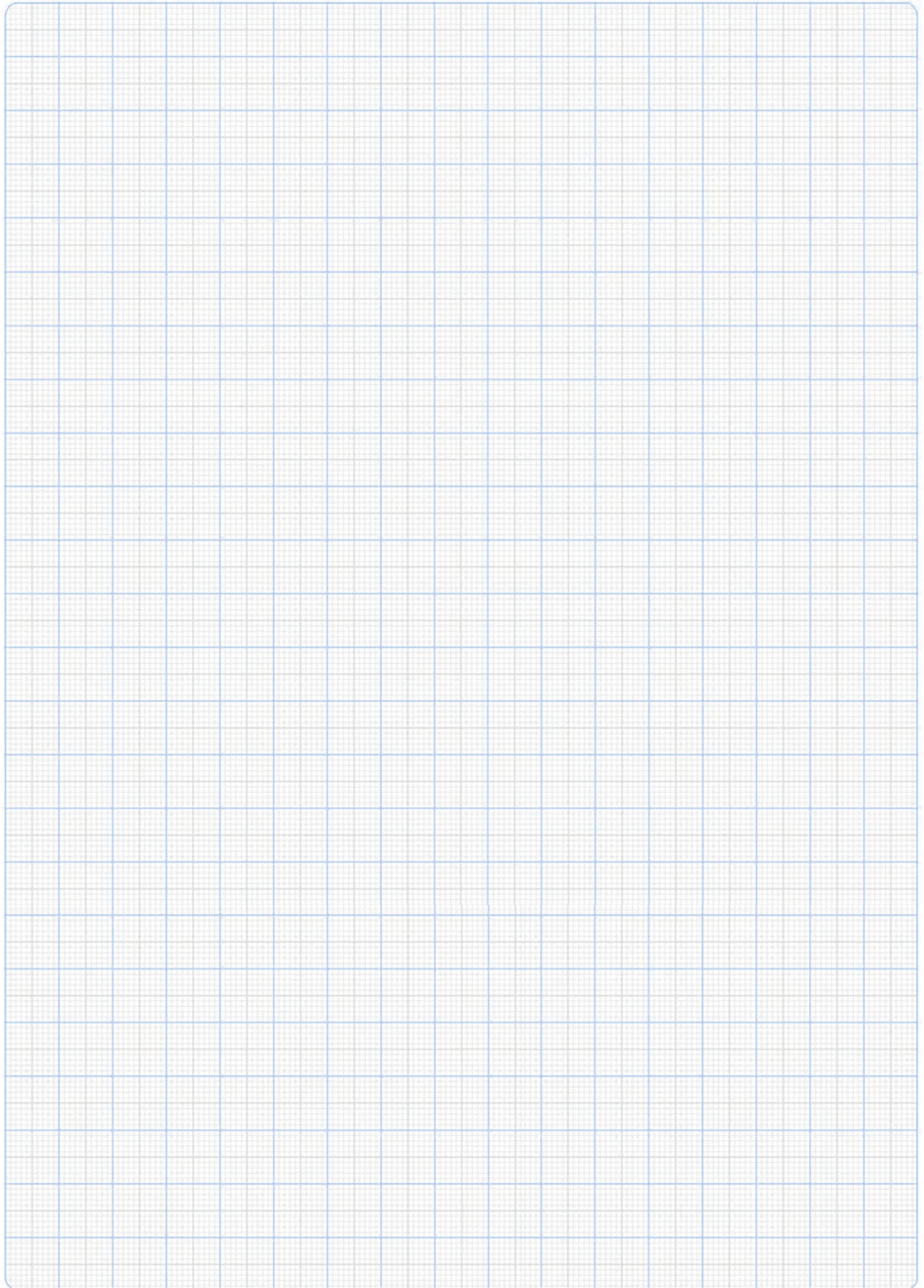

Q-Lock Overdenture Restoration Flow Chart

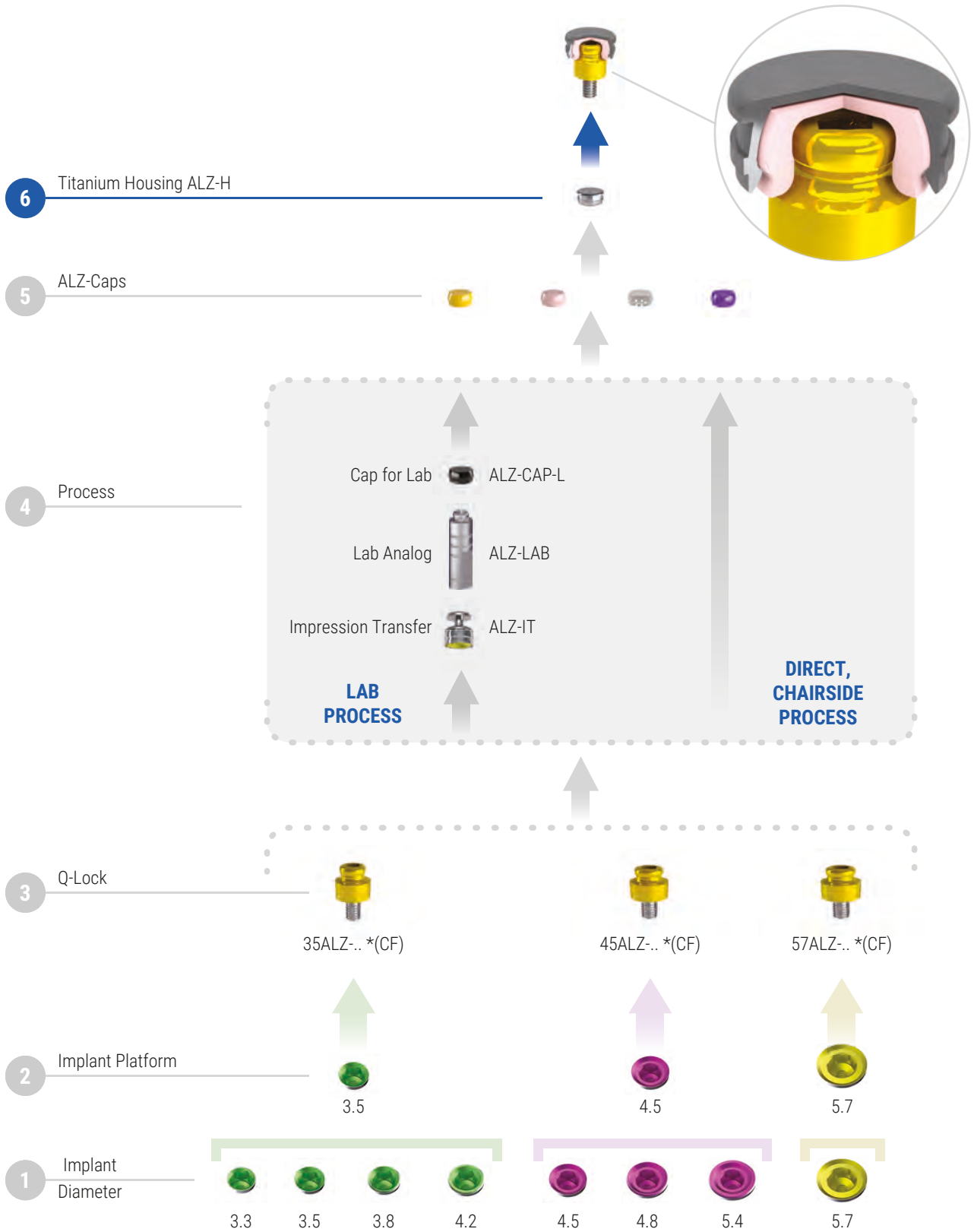

PROSTHETIC COMPONENTS

*(CF) - see page 50

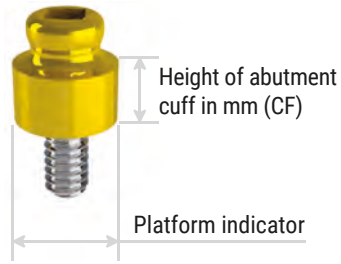

35 ALZ - 3

PLATFORM INDICATOR PRODUCT ABBREVIATION CF INDICATOR

Q-Lock Abutments

	1	CF 0.50	CF 1.00	CF 2.00	CF 3.00	CF 4.00	CF 5.00	CF 6.00	CF 7.00
3.5		35ALZ-0.5	35ALZ-1	35ALZ-2	35ALZ-3	35ALZ-4	35ALZ-5	35ALZ-6	35ALZ-7
4.5		45ALZ-0.5	45ALZ-1	45ALZ-2	45ALZ-3	45ALZ-4	45ALZ-5	45ALZ-6	45ALZ-7
5.7		57ALZ-0.5	57ALZ-1	57ALZ-2	57ALZ-3	57ALZ-4	57ALZ-5	57ALZ-6	57ALZ-7



35 ALZ - 3 - SET

PLATFORM INDICATOR PRODUCT ABBREVIATION CF INDICATOR SET INDICATOR

Q-Lock Set Included Items

- 7 Titanium Housing ALZ-H
- 3-6 Caps
ALZ06-CAP
ALZ12-CAP
ALZ18-CAP
ALZ27-CAP
- 2 Protective Disc ALZ-P
- 1 Q-Lock Abutment ..ALZ-.

Q-Lock Abutment Instruments and Components

INSERTION/ EXTRACTION TOOL FOR PLASTIC CAPS

 (image scaled)	ALZ-002	
--	---------	--

SCREWDRIVER WITH INTERCHANGEABLE HOLDER

	ALZ-001	1.25 mm square
---	---------	----------------

LAB ANALOG

	ALZ-LAB	
---	---------	--

IMPRESSION TRANSFER WITH INTERCHANGEABLE CAP

	ALZ-IT	
---	--------	--

PROTECTIVE DISC

2 	ALZ-P	
---	-------	--

HOUSING FOR Q-LOCK CAPS (TITANIUM)

7 	ALZ-H	
---	-------	--

PLASTIC INSERT CAP FOR LAB USE

 (black)	ALZ-CAP-L	
---	-----------	--

PLASTIC INSERT CAPS

3  (yellow)	ALZ06-CAP	very soft	1.32lb / 0.6kG
4  (pink)	ALZ12-CAP	soft	2.65lb / 1.2kG
5  (clear)	ALZ18-CAP	standard	3.97lb / 1.8kG
6  (purple)	ALZ27-CAP	strong	5.95lb / 2.7kG

PROSTHETIC COMPONENTS

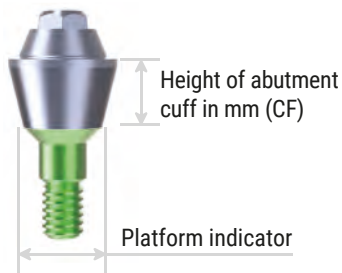

35	AMZ	.3	- 0
PLATFORM INDICATOR	PRODUCT ABBREVIATION	CF INDICATOR	ANGULATION INDICATOR

Multi-Unit Abutments

		CF 1.0	CF 2.0	CF 3.0	CF 4.0	CF 5.0
3.5		35AMZ-1-0	35AMZ-2-0	35AMZ-3-0	35AMZ-4-0	35AMZ-5-0
4.5		45AMZ-1-0	45AMZ-2-0	45AMZ-3-0	45AMZ-4-0	45AMZ-5-0
5.7		57AMZ-1-0	57AMZ-2-0	57AMZ-3-0	57AMZ-4-0	57AMZ-5-0

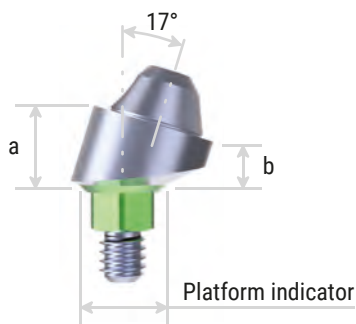

35	AMZ	.3	- 17
PLATFORM INDICATOR	PRODUCT ABBREVIATION	a INDICATOR	ANGULATION INDICATOR

17° Multi-Unit Abutments

		a = 2.4 mm b = 1.0 mm	a = 2.5 mm b = 1.0 mm	a = 3.0 mm b = 2.0 mm
3.5		35AMZ-2-17		
4.5				45AMZ-3-17

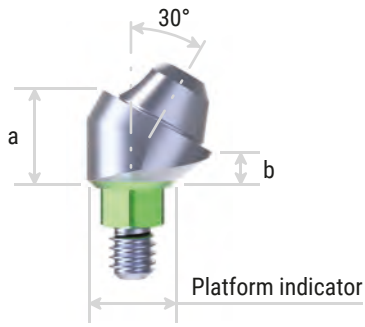

35	AMZ	.3	-30
PLATFORM INDICATOR	PRODUCT ABBREVIATION	a INDICATOR	ANGULATION INDICATOR

30° Multi-Unit Abutments

a = 3.4 mm b = 1.0 mm			a = 4.0 mm b = 2.0 mm		
3.5		35AMZ-3-30		35AMZ-4-30	
4.5		45AMZ-3-30		45AMZ-4-30	

PROSTHETIC COMPONENTS

Multi-Unit Instruments and Components

MULTI-UNIT LABORATORY ANALOG

	AMZ-LAB	
--	---------	--

MULTI-UNIT REPLACEMENT SCREW

	AMZ-0001	
	AMZ-0002	for Angled Abutment
	AMZ-0003	Long

ANGLED MULTI-UNIT ABUTMENT DELIVERY AID - SCREW

 (image scaled)	AMZ-D	
--------------------	-------	--

HEX DRIVER FOR STRAIGHT MULTI-UNIT ABUTMENTS

	AMZ-HD	
--	--------	--

TITANIUM HEALING CAP WITH SCREW (AMZ-0001)

	AMZ-HC	+
--	--------	---

IMPRESSION POST FOR OPEN AND CLOSED TRAY WITH SCREW (AMZ-0001, AMZ-0003)

	AMZ-IP	+ (image scaled)
--	--------	---------------------





TITANIUM TEMPORARY ABUTMENT WITH SCREW (AMZ-0001)

	AMZ-TT	+
--	--------	---

CASTABLE ABUTMENT WITH SCREW (AMZ-0001)

	AMZ-CA	+
--	--------	---

Instruments for Impression Posts and Abutment Fixation

	Q2114	Screwdriver	1.25 mm hex	L 20 mm
	Q2114L			L 30 mm
	Q2112	Screwdriver hand piece	Fit to ratchet QX30	
 (image scaled)	QX30	Universal torque ratchet	10-45 Ncm and fix	

Torque Ratchet Instructions

1

By turning lower part of the ratchet, torque can be adjusted



2

By flipping the ratchet, direction can be adjusted, **note the marking for "IN" or "OUT"**



3

Once adjusted correctly, attach the handpiece with screwdriver to the ratchet



4

The ratchet will disengage when the adjusted torque has been reached and you will hear a distinct **"click"** sound

CLICK!



IMPLANTOLOGY PRODUCTS

IMPLANTOLOGY
PRODUCTS



Q-Bone Pin System Instruments and Pins

SETTING INSTRUMENTS

5		BPS-100-100	titanium	straight	end-piece
		BPS-100-105		angled	
		BPS-000-010		handle	
		BPS-000-020		straight	
		BPS-000-030		angled	

HEX SCREWDRIVER

4		BPS-100-101	titanium	0.9 mm hex	
---	--	-------------	----------	------------	--

FIXATION PIN

2		BPS-100-001	Length 3 mm	0.9 mm hex	
3		BPS-100-002	Length 5 mm		

STERI-CONTAINER

1	(image scaled)	BPS-100-104	titanium – autoclavable	holds 15 pins	
---	----------------	-------------	-------------------------	---------------	--

Q-Bone Pin System Complete Kit

- 5

Pin Setting Instrument
BPS-100-100

- 4

Hex Screwdriver
BPS-100-101

- 3

5 Pins 5 mm
BPS-100-002

- 2

10 Pins 3 mm
BPS-100-001



- 1

Steri-container
BPS-100-104



Q-Mesh & Titanium Mesh

Q-MESH (CUSTOM)

 (image scaled)	20500 Q-Mesh	titanium	3D Micromesh 0.2 mm thick for reconstruction of atrophic maxilla	To be fixed with screws diameter 1.3 mm
---	--------------	----------	---	---

TITANIUM MESH

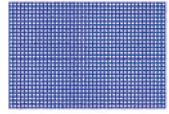
	MT-10-34	30 x 40 mm	0.1 mm thick	
	MT-10-46	40 x 60 mm		
	MT-20-46	40 x 60 mm	0.2 mm thick	

IMPLANTOLOGY
PRODUCTS

Q-MultiTractor Kit

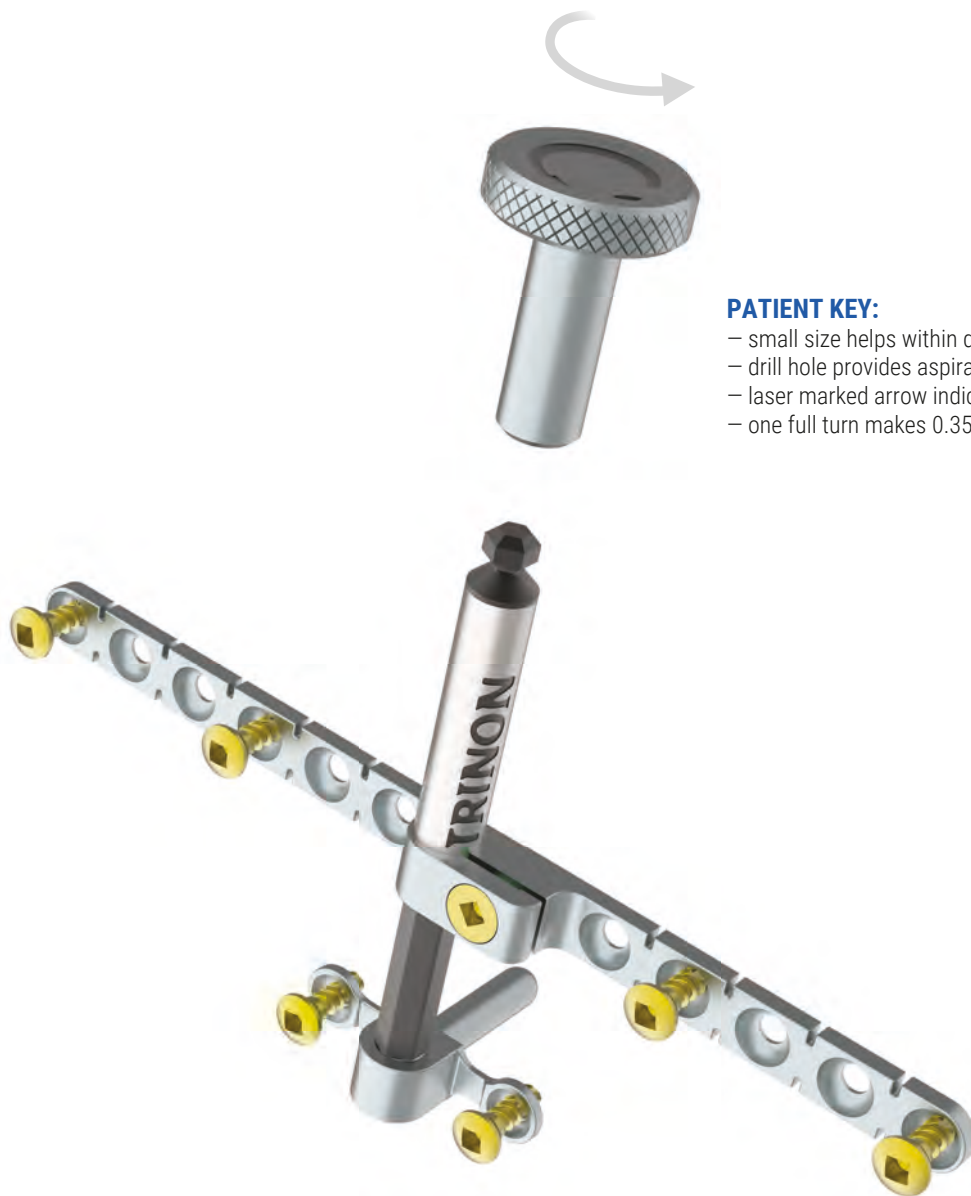
**PATIENT KEY:**

- small size helps within difficult access areas
- drill hole provides aspiration protection
- laser marked arrow indicates the right direction of rotation
- one full turn makes 0.35 mm distracted height

**HIGH-PRECISION CONICAL THREAD**















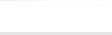

- avoids rotation movements
- fixes distractor spindle

PIN TO STABILIZE DISTRACTIONVECTOR

- neutralises lingualisation
- allows for minimally invasive surgery



Q-MultiTractor Kit Components

 <p>10500 Q- MultiTractor Standard configuration</p>		<p>2  10568 Rotating drill</p> <p>3  10557 Drill for drilling gauge 10 555</p> <p>4  10556 Drill for fixing screw</p> <p>5  10558 Screwdriver, endpiece</p> <p>9  10561 Holding key for spindle</p> <p>13  10555 Drilling gauge for standard base plate</p> <p>14  10559 Screwdriver, handpiece</p>
<p>1  10550 Distractor spindle</p> <p>7  10550 Key</p> <p>6  10554 Base plate, standard</p> <p>11  10552 Transport plate, double</p>	<p>PLATE</p> <p>10  10551 Universal transport plate, single</p> <p>12  10553 Base plate, wide</p>	<p>8  SCD 1305 Fixing screw Ø 1.3 mm L = 5 mm</p> <p> SCD 1307 Fixing screw Ø 1.3 mm L = 7 mm</p> <p> SCD 1309 Fixing screw Ø 1.3 mm L = 9 mm</p>

IMPLANTOLOGY PRODUCTS

1

A Guide Drill (Diameter 2mm) is used to drill pilot holes into the plastic model.

2

Guide Pins (Diameter 2 mm) are inserted into the guide holes to check drill depth and to locate the Master Tube and Drill Guides.

3

The Master Tube and Drill Guide (Diameter 2 mm) are inserted into the mold.

4

To fix the Master Tube with a surgical stent, resin is applied onto the model.

5

Finally the surgical stent is removed from the plastic model and the Drill Guides are replaced as required by the implant system. If required, Manual Drill Guides can be used with the RGIT.

APPLICABLE FOR ALL IMPLANT SYSTEMS

The Reverse Guide Implant Technique utilizes surgical guides without the use of any software.

It offers surgeons an easy preparation, high precision and increased safety of implant placement.

The technique is practice based and offers a fast and low-cost solution for doctors.

Only one disposable Master Tube is required per implant.

The technique is easy to correct making it ideal for beginners and an invaluable aid for professionals.



NO MORE DRILLING

With its new geometry designed by Trinon Titanium the Twisted Trocar Self Drilling Screw is ideally suited as replacement for applications where drilling is required.

The TT screw is easily placed in any bone, even cortical bone.

HOW IT'S DONE

This new screw type is based on the trocar principle with an added geometrical feature to enhance insertion and reduce the strength needed for fixation. With a specialized twist of the trocar tip the TT screw offers surgeons a new tool for fixation into any bone type with ease.

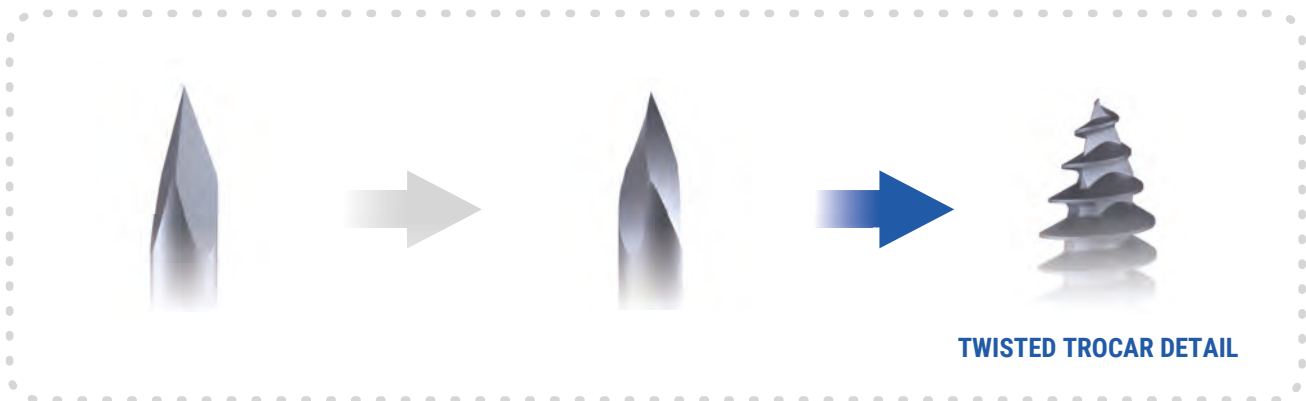

The TT bone screws are available in any size, any head configuration and any thread pitch from Trinon Titanium/Germany.







Q-Bone Graft Kit Components







SCREWDRIVER

 (image scaled)	10559	hand-piece	Universal
	10558	end-piece	Ø 1.3 mm
	10565		Ø 1.0 mm

DRILL FOR FIXING SCREW

	10563	for fixing screw	Ø 1.0 mm
	10569		Ø 1.3 mm
	10564	for bone block	Ø 1.4 mm

FIXING SCREW

	SCD1003		Ø 1.0 mm	Length 3 mm
	SCD1005			Length 5 mm
	SCD1007			Length 7 mm
	SCD1307	self-tapping	Ø 1.3 mm	Length 7 mm
	SCD1309			Length 9 mm
	SCD1311			Length 11 mm
	SCD1313			Length 13 mm

Since 1999 the Q-Implant family provides implant solutions to dentists looking for a reliable and cost-effective implant system for their patients.

QZA-Implant

The Trinon QZA-Implant is a bone level implant with a tapered hexagon connection. With 8 available diameters, it is the most flexible Q-Implant on the market and ideally suited for the aesthetic and posterior regions.



Q2-Implant

The Q2-Implant is a bone level implant with external hex connection. Ideally used in multi-tooth restorations the implant features two types of thread designs, the classic wide flank and the modern narrow flank design.



QK-Implant

The QK-Implant is a tissue level implant with a conical internal octagon connection. Ideally used at tight interocclusal space in the posterior region.



GIP2-Implant

The GIP2-Implant is an ultra short, hollow cylinder implant with an external cone connection. Unique in its design the implant is ideally used when strong atrophy is present in the posterior region.



Q-Implant Single Stage

The classic Q-Implant is a long-running favorite in single piece implants. The wide flank thread design achieves a formidable primary stability required for immediate loading cases.



Q3-Implant for Overdenture

The classic single piece Q3-Implant features a ball-head abutment to be used in denture cases. The implant offers an effective solution when cost is a factor in denture cases.



GIP1-Implant Single Stage

The GIP1-Implant is an ultra short, hollow cylinder implant with a single-piece Q-Cone abutment. Unique in its design the implant is ideally used when strong atrophy is present in the posterior region.



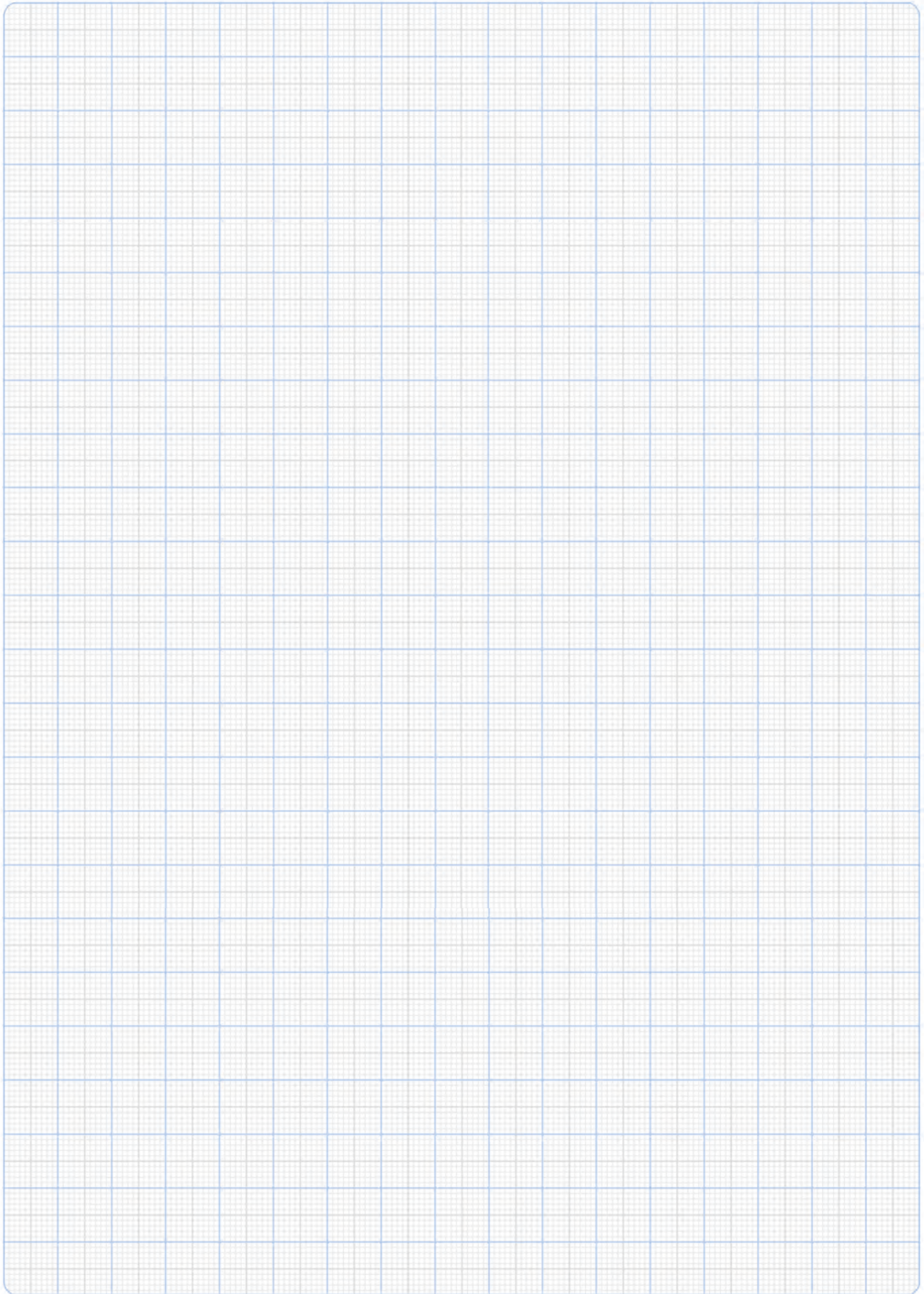

Q-IMPLANT MARATHON: HANDS-ON IMPLANTOLOGY COURSES

LEARNING BY DOING

Since 2003, the Q-Implant Marathon has offered hands-on training that incorporates a live patient model. Participants spend five days assisting and leading surgeries under the supervision of TCP's experienced surgical team. The Academy of General Dentistry accredits the Q-Implant Marathon and all participants are eligible to receive 60 continuing education credit hours. The courses are based on collaboration between the Trinon Collegium Practicum and established universities and clinics in the Dominican Republic, Cambodia and Laos.

LEVEL 1

Participants lead the placement of 30 implants, while assisting on dozens more

LEVEL 2

Participants perform 5 sinus lifts via lateral window and piezosurgery methods, and learn foundational bone splitting techniques

LEVEL 3

Participants learn advanced grafting techniques, such as ramus and chin block grafts, and titanium mesh reconstruction



TRINON
COLLEGIUM
PRACTICUM

www.trinon-collegium-practicum.org

For more Information:

www.ImplantologyCourses.com

Tel: +1 (630) 705-1002
Toll Free: (877) 705-1002

info@implantologycourses.com



Information

Components are updated periodically, check with your local Trinon Titanium representative on current models. Please follow "Instructions for Use" for individual components. Images are not to scale – see dimensions or inquire with your local Trinon Titanium representative. The materials in this catalog are intended to be for informational use only and are not suggestive of clinical guidance.

Certain components not available in all countries. Please check availability with your local representative.

Disclaimer of Liability

Trinon Titanium dental implants may only be used in conjunction with the associated original components and instruments according to Trinon Titanium instructions for use. Use of any non-Trinon Titanium products in conjunction with Trinon Titanium implants will void any warranty or any other obligation, expressed or implied, of Trinon Titanium.

Disclaimer

Trinon Titanium makes every effort to maintain the accuracy and quality of the information provided in this catalog. However, Trinon Titanium cannot guarantee and assumes no legal liability or responsibility for the accuracy or completeness of the information provided.

The QZA Dental Implant System has not been evaluated for safety and compatibility in the MR environment. It has not been tested for heating, migration, or image artifact in the MR environment. The safety of QZA Dental Implant System in the MR environment is unknown. Scanning a patient who has this device may result in patient injury.

Produced by:

TRINON Titanium GmbH
Augarten str.1
D-76137 Karlsruhe
Germany

Tel: + 49 721 932700
Fax: +49 721 24991

www.trinon.com

TRINON
TITANIUM

USA Distributor:

Optimum Solutions
Group LLC

Tel: +1 (630) 705-1002
Toll Free: (877) 705-1002
Fax: +1 (630) 705-1003

www.qimplant.com